



2016

The Utilization of Liquid Chromatography Tandem Mass Spectrometry and Related Techniques for the Analysis and Identification of Emerging Contaminants in Aqueous Matrices

Matthew Reichert
Loyola University Chicago

Follow this and additional works at: https://ecommons.luc.edu/luc_diss

 Part of the [Environmental Chemistry Commons](#)

Recommended Citation

Reichert, Matthew, "The Utilization of Liquid Chromatography Tandem Mass Spectrometry and Related Techniques for the Analysis and Identification of Emerging Contaminants in Aqueous Matrices" (2016). *Dissertations*. 2294.

https://ecommons.luc.edu/luc_diss/2294

This Dissertation is brought to you for free and open access by the Theses and Dissertations at Loyola eCommons. It has been accepted for inclusion in Dissertations by an authorized administrator of Loyola eCommons. For more information, please contact ecommons@luc.edu.



This work is licensed under a [Creative Commons Attribution-NonCommercial-No Derivative Works 3.0 License](#).
Copyright © 2016 Matthew Reichert

LOYOLA UNIVERSITY CHICAGO

THE UTILIZATION OF LIQUID CHROMATOGRAPHY TANDEM MASS SPECTROMETRY
AND RELATED TECHNIQUES FOR THE ANALYSIS AND IDENTIFICATION OF
EMERGING CONTAMINANTS IN AQUEOUS MATRICES

A DISSERTATION SUBMITTED TO
THE FACULTY OF THE GRADUATE SCHOOL
IN CANDIDACY FOR THE DEGREE OF
DOCTOR OF PHILOSOPHY

PROGRAM IN CHEMISTRY

BY

MATTHEW REICHERT

CHICAGO, ILLINOIS

DECEMBER 2016

Copyright by Matthew Reichert, 2016
All rights reserved.

ACKNOWLEDGEMENTS

I would first like to thank Dr. M. Paul Chiarelli for accepting me into his research group and giving me the opportunity to pursue my Ph.D. His knowledge of mass spectrometry helped me to expand my knowledge in mass spectrometry and other instrumentation. He helped me to grow as a chemist and a researcher by allowing me the time and resources to solve the problems I encountered.

Thank you also to my dissertation committee members, Dr. Martina Schmeling, Dr. Duarte Mota De Freitas, and Dr. Tham Hoang for taking the time to support and encourage me along the final stages of my journey to a Ph.D. Their advice and suggestions were invaluable and will be remembered as I begin a new chapter in my life.

I also extend my appreciation to Dr. Daryl Giblin and Dr. Michael L. Gross of Washington University, St. Louis, MO and Dr. Alfred L. Yergey of the NIH for their contributions to my work through sample and data analysis to which I would otherwise not have had access.

Past and present members of the Chiarelli group have also been of great value. The many conversations I have had with Dr. Deepika Panawennage and Kathryn Renyer have been resourceful as a means to discuss project ideas and troubleshooting instrumentation or experimental issues. The environment of support and camaraderie made it much easier to come in each day. The many undergraduates who have assisted

me on my projects have been valuable assets as well. The countless hours they spent doing sample extractions allowed me to work on other facets of my projects.

Thank you also to all the faculty, staff, and other graduate students at Loyola University for all the support, encouragement, and direction that they provided me.

Thank you to all my friends and family who throughout this process have been praying for me and encouraging me. Thank you to my church Sunday school class and Life Group for the support and encouragement you have given me over the years.

My deepest thanks also go out to my parents for encouraging me to pursue my dreams. Thank you for all your love, encouragement, and support through my many years of schooling.

Finally, I would like to thank my wife Kara for her continual love and support through the ups and downs of graduate school. Thank you for the hours you spent proofreading papers and listening to me complain or just ramble on about my research, being a Teaching Assistant or whatever. Thank you for never giving up on me and trying to push me forward toward the end goal.

To those who instilled in me a desire to learn.

More than one-half of the world's major rivers are being seriously depleted and polluted, degrading and poisoning the surrounding ecosystems, thus threatening the health and livelihood of people who depend upon them for irrigation, drinking and industrial water.

- Ismail Serageldin

In an age when man has forgotten his origins and is blind even to his most essential needs for survival, water along with other resources has become the victim of his indifference.

- Rachel Carson, *Silent Spring*

TABLE OF CONTENTS

ACKNOWLEDGEMENTS	iii
LIST OF TABLES	ix
LIST OF FIGURES	x
LIST OF SCHEMES	xvi
LIST OF EQUATIONS	xvii
LIST OF ABBREVIATIONS	xviii
ABSTRACT	xxi
CHAPTER ONE: THE HISTORY OF WATER TREATMENT AND CURRENT CHALLENGES	1
Introduction	1
Pesticides	7
Polycyclic Aromatic Hydrocarbons	9
Disinfection By-Products	12
Pharmaceuticals and Personal Care Products	17
Phenol Derivatives	22
CHAPTER TWO: METHODS FOR THE ANALYSIS OF EMERGING CONTAMINANTS	29
Introduction	29
Ionization Sources	29
Electron Ionization	29
Electrospray Ionization	30
Positive Chemical Ionization	31
Thermal Desorption Negative Chemical Ionization	32
Mass Analyzers	33
Quadrupole Ion-Trap Mass Analyzer	33
Triple Quadrupole Mass Analyzer	36
Time-of-Flight Mass Analyzer	39
Orbitrap Mass Analyzer	40
Fourier Transform Ion Cyclotron Resonance Mass Analyzer	41
Detectors	43
Electron Multiplier	43
Multichannel Plate	44
Comparison of Mass Spectrometry Instrumentation	45
Mass Spectrometry Based Methods	49
Other Instrumental Methods	58

Ion Chromatography	58
Electrochemical Techniques	59
Diode Array and Fluorescence Detectors	59
Nuclear Magnetic Resonance Spectroscopy	60
Study Objectives	61
CHAPTER THREE: THE EXPERIMENTAL DESIGN	64
Reagents	64
Water Sampling	64
Sample Extraction	65
Reaction Design for the Oxidation Products of Triclosan	67
Sample Analysis	67
Empirical Formula Determinations	71
CHAPTER FOUR: WATER DISINFECTION BY-PRODUCTS FORMED FROM 3-BROMO-1-CHLORO-5,5-DIMETHYLHYDANTOIN (BCDMH)	72
Introduction	72
GC-ECD Analysis	75
TD-NCI-TOF-MS Analysis	77
Empirical Formulas of Fragment Ions and Potential Precursor Ions	85
LC-TOF-MS Analysis	88
Hydrolysis Studies of 3-Bromo-1-Chloro-5,5-Dimethylhydantoin (BCDMH)	94
Conclusion	97
CHAPTER FIVE: STUDIES OF TRICLOSAN OXIDATION BY HYDROGEN PEROXIDE	100
Introduction	100
Environmental Effects of Triclosan Exposure	104
Disposition of Triclosan during Water Treatment	105
Preliminary Reaction Screening	111
Identification of the Unknown Oxidation Products	114
Effects of pH on Product Formation	122
Conclusion	127
LIST OF REFERENCES	129
VITA	150

LIST OF TABLES

Table 1. Summary of chromatographic conditions for the analysis of triclosan oxidation products	70
Table 2. Mass spectrometric conditions for triclosan oxidation product analyses	70
Table 3. Triclosan molecular ion masses observed in extractions of Kirie and Stickney Wastewater Treatment Plant effluents	101
Table 4. Summary of triclosan oxidation products by treatment or reaction conditions	111

LIST OF FIGURES

Figure 1. Map of Chicago area Lake Michigan shoreline and waterways with sampling points indicated by drops (CSSC = Chicago Sanitary and Ship Canal)	3
Figure 2. Sources of emerging contaminants	6
Figure 3. Structures of the four EPA regulated THMs: (A) bromoform, (B) bromodichloromethane, (C) chloroform, and (D) dibromochloromethane	13
Figure 4. Structures of (A) 2,6-dichloro-1,4-benzoquinone, (B) 2,6-dichloro-3-methyl-1,4-benzoquinone, (C) 2,3,6-trichloro-1,4-benzoquinone, and (D) 2,6-dibromo-1,4-benzoquinone.	14
Figure 5. Structures of the five EPA regulated HAAs: (A) chloroacetic acid, (B) dichloroacetic acid, (C) trichloroacetic acid, (D) bromoacetic acid, and (E) dibromoacetic acid	16
Figure 6. Schematic of electrospray ionization	31
Figure 7. Example of an ion trap cut in half	34
Figure 8. Modeled trajectory of an ion having a mass-to-charge ratio of 105 trapped in a 3-dimensional ion trap mass analyzer	35
Figure 9. A single quadrupole mass analyzer	37
Figure 10. Configuration of a triple quadrupole mass spectrometer	37
Figure 11. Diagram of the operation of a time-of-flight mass spectrometer	39
Figure 12. Cutaway of an orbitrap mass analyzer	41
Figure 13. Schematic and operation of an FTICR-MS	42
Figure 14. Diagrams of (A) a discrete dynode electron multiplier and (B) a continuous dynode electron multiplier	44

Figure 15. Schematic of a multichannel plate detector	45
Figure 16. Schematic diagrams of MS/MS experiments	51
Figure 17. The structure of 3-bromo-1-chloro-5,5-dimethylhydantoin (BCDMH)	73
Figure 18. GC-ECD chromatograms of (A) dibromochloromethane, (B) bromoform, and (C) an extract of hot tub water	76
Figure 19. TD-NCI-TOF-MS full scan mass spectrum averaged over minutes 4-13 (inset showing exact isotope masses)	79
Figure 20. TD-NCI-TOF-MS extracted ion chromatogram for (A) m/z 79 and (B) m/z 81	79
Figure 21. Mass spectrum of a monobrominated compound having monoisotopic masses at m/z 135.9167 and m/z 137.9147	80
Figure 22. Mass spectrum of a monobrominated compound having monoisotopic masses at m/z 175.9123 and m/z 177.9097	80
Figure 23. Mass spectrum of a monobrominated compound having monoisotopic masses at m/z 189.9273 and m/z 191.9253	81
Figure 24. TD-NCI-TOF-MS extracted ion chromatograms for the (A) m/z 135.9 ion, (B) m/z 175.9 ion, and (C) m/z 189.9 ion	82
Figure 25. Mass spectrum of a dibrominated compound having monoisotopic masses at m/z 214.8337, m/z 216.8317 and m/z 218.8296	83
Figure 26. TD-NCI-TOF-MS extracted ion chromatograms for the (A) m/z 135.9 ion, (B) m/z 214.8 ion, (C) m/z 216.8 ion, and (D) m/z 218.8	84
Figure 27. The structure of 2-oxoacetyl bromide	85
Figure 28. (A) The structure of 1,2-dibromo-1-hydroxy-2-oxy-ethane and (B) the resonance stabilized 1,2-dibromo-oxoethoxy radical	86
Figure 29. The structure of 3-bromo-2,5-furandione	87
Figure 30. The proposed structures matching the formula C ₅ H ₃ BrO ₃	88

Figure 31. LC-TOF-MS full scan of dibrominated ions at m/z 170.8/172.8/174.8 and m/z 214.8/216.8/218.8 from the hot tub sample collected on (A) Monday (with the structure of dibromoacetic acid inset) and (B) Friday	89
Figure 32. LC-TOF-MS full scan mass spectra of samples from Lake Michigan at (A) W. Bryn Mawr Ave. and (B) Berger Park indicating the presence of dibromoacetic acid	91
Figure 33. LC-TOF-MS full scan of a dibrominated ion at m/z 238.8/240.8/242.8	92
Figure 34. The structure of 2,2-dibromo-2-cyanoacetamide	92
Figure 35. LC-TOF-MS full scan of a dibrominated ion at m/z 250.8/252.8/254.8 from the sampling of a hot tub on (A) Monday, (B) Wednesday, and (C) Friday in the same week	93
Figure 36. The structure of 1,1-dibromo-methanesulfonic acid	94
Figure 37. NCI-TOF mass spectrum of two monobrominated ions at (m/z 242.9/244.9 and m/z 246.0/248.0) from the 24 hour extract of BCDMH in ultrapure water	95
Figure 38. The nine structural matches for the formula C ₉ H ₃ BrN ₄ that fit within 0.4 ppm mass accuracy	96
Figure 39. The structure of triclosan	100
Figure 40. LC-TOFMS extracted ion chromatograms of the (A) m/z 290.9 ion, (B) m/z 288.9 ion, and (C) m/z 286.9 ion of the ³⁵ Cl and ³⁷ Cl isotopologues of triclosan	102
Figure 41. LC-TOFMS extracted ion chromatograms of the (A) m/z 290.9 ion, (B) m/z 288.9 ion, and (C) m/z 286.9 ion of the ³⁵ Cl and ³⁷ Cl isotopologues of triclosan	102
Figure 42. Extracted ion chromatograms indicating the presence of triclosan via the fragmentation of chlorine isotopes from selected isotopologues ((A) m/z 291 → m/z 35, (B) m/z 291 → m/z 37, and (C) m/z 287 → m/z 35)	103
Figure 43. LC-TOFMS extracted ion chromatograms of the (A) m/z 160.9 ion, (B) m/z 162.9 ion, and (C) m/z 164.9 ion	113

Figure 44. Negative ion LC-TOFMS spectra of the dichlorophenols eluting at (A) 21 minutes, (B) 22 minutes, and (C) 24 minutes	113
Figure 45. LC/MS/MS extracted ion chromatogram for m/z 161 from a reaction preformed at a pH of approximately 10	115
Figure 46. Product ion spectra of the (A) m/z 161 and (B) m/z 163 molecular ions for the unknown eluting at 15.8 minutes	115
Figure 47. The structure of 2,3-dichlorophenol and its product ion spectrum of m/z 161 (the (M-H) ⁻ ion having a formula of ¹² C ₆ H ₃ ³⁵ Cl ₂ O)	116
Figure 48. The structure of 2,4-dichlorophenol and its product ion spectrum of m/z 161 (the (M-H) ⁻ ion having a formula of ¹² C ₆ H ₃ ³⁵ Cl ₂ O)	116
Figure 49. The structure of 2,5-dichlorophenol and its product ion spectrum of m/z 161 (the (M-H) ⁻ ion having a formula of ¹² C ₆ H ₃ ³⁵ Cl ₂ O)	116
Figure 50. The structure of 2,6-dichlorophenol and its product ion spectrum of m/z 161 (the (M-H) ⁻ ion having a formula of ¹² C ₆ H ₃ ³⁵ Cl ₂ O)	117
Figure 51. The structure of 3,4-dichlorophenol and its product ion spectrum of m/z 161 (the (M-H) ⁻ ion having a formula of ¹² C ₆ H ₃ ³⁵ Cl ₂ O)	117
Figure 52. The structure of 3,5-dichlorophenol and its product ion spectrum of m/z 161 (the (M-H) ⁻ ion having a formula of ¹² C ₆ H ₃ ³⁵ Cl ₂ O)	117
Figure 53. Extracted ion chromatograms of m/z 161 from a pH 10 reaction (A) not spiked, and spiked with (B) 2,4-dichlorophenol, (C) 2,5-dichlorophenol, and (D) 3,4-dichlorophenol	119
Figure 54. Full scan spectrum of the unknown peak centered at 22.5 minutes show a dichlorinated compound (isotope ratio of about 100:64:10)	121
Figure 55. Product ion spectra of the late eluting peak for (A) m/z 161 and (B) m/z 163	121
Figure 56. A proposed mechanism for ionization of the hypothesized semi-quinone structure (reactant) using ESI	122
Figure 57. Extracted ion chromatogram of m/z 161 from a mixture of the six dichlorophenol standards each at a concentration of 167 µg/mL	123

Figure 58. Extracted ion chromatogram of m/z 161 from a reaction performed at a pH of approximately 3	124
Figure 59. Extracted ion chromatogram of m/z 161 from a reaction performed at a pH of approximately 4	124
Figure 60. Extracted ion chromatogram of m/z 161 from a reaction performed at a pH of approximately 5	124
Figure 61. Extracted ion chromatogram of m/z 161 from a reaction performed at a pH of approximately 6	125
Figure 62. Extracted ion chromatogram of m/z 161 from a reaction performed at a pH of approximately 7	125
Figure 63. Extracted ion chromatogram of m/z 161 from a reaction performed at a pH of approximately 8	125
Figure 64. Extracted ion chromatogram of m/z 161 from a reaction performed at a pH of approximately 9	126
Figure 65. Extracted ion chromatogram of m/z 161 from a reaction performed at a pH of approximately 10	126
Figure 66. Comparison of the relative concentration (peak area) of 2,4-dichlorophenol, 2,5-dichlorophenol, 3,4-dichlorophenol, and the unknown based on reaction pH	127

LIST OF SCHEMES

Scheme 1. Phase I biotransformation of testosterone by hydroxylation	21
Scheme 2. Phase II glucuronidation of the antibiotic chloramphenicol	21
Scheme 3. Proposed pathways for the degradation of triclosan in the environment and advanced oxidation water treatment processes	28
Scheme 4. Reactions for the ionization of the reagent gas in positive chemical ionization	32
Scheme 5. Generation of ions of a brominated molecule, $M(\text{Br})_x$, using TD-NCI	33
Scheme 6. The reaction of BCDMH during the disinfection process	73
Scheme 7. The ionization and possible fragmentation of a halogenated compound in TD-NCI	78
Scheme 8: The generation of hydroxyl radicals from hydrogen peroxide in the Fenton reaction	108
Scheme 9: The generation of hydroxyl radicals from hydrogen peroxide in the Fenton-like reaction using Fe^{3+}	109
Scheme 10. Proposed formation of three isomeric dichlorophenols from the reaction of triclosan with hydrogen peroxide at a pH of approximately 10	113
Scheme 11. The proposed mechanism of triclosan oxidation leading to the formation of 3,4-dichlorophenol	120
Scheme 12. The proposed mechanism of triclosan oxidation leading to the formation of 2,5-dichlorophenol	120

LIST OF EQUATIONS

Equation 1. Generalized equation for the path of an ion in the three dimensions where u represents the x , y , and z coordinates, a and q are dimensionless trapping parameters, Ω is the radial frequency of the applied potential, and $\xi = \Omega t / 2$	35
Equation 2. Equation for the potential distribution at time t for a hyperbolic mass filter	38
Equation 3. Equation of motion for an ion having a given mass-to-charge ratio in the x - and y -axes as it relates to the applied DC	38
Equation 4. Equation of motion for an ion having a given mass-to-charge ratio in the x - and y -axes as it relates to the applied RF	38
Equation 5. Equation for kinetic energy	40
Equation 6. Equation relating an ion's mass-to-charge ratio in terms of the velocity of the ion	40
Equation 7. Equation relating the time until an ion is detected to the velocity given to an ion, the distance the ion travels and the mass and charge of the ion	40
Equation 8. Equation relating the ion mass-to-charge ratio to the frequency of ion oscillation along the z -axis	41
Equation 9. Equation for the cyclotron frequency as it relates to the magnetic field and the ion mass and charge	43

LIST OF ABBREVIATIONS

AC	Alternating current
BCDMH	1-Bromo-3-chloro-5,5-dimethylhydantoin
BPA	Bisphenol A
CAS	Chemical Abstracts Service
CID	Collision induced dissociation
CNL	Constant neutral loss
DBPs	Disinfection by-products
DC	Direct current
DNA	Deoxyribonucleic acid
ECD	Electron capture detection
EI	Electron ionization
EPA	Environmental Protection Agency
EROD	7-ethoxyresorufin-O-deethylase
ESI	Electrospray ionization
FTICR	Fourier transform ion cyclotron resonance
GC	Gas chromatography
GC/MS	Gas chromatography mass spectrometry
HAAs	Haloacetic acids

HMBC	Heteronuclear multiple bond correlation
HPLC	High pressure liquid chromatography
HRMS	High resolution mass spectrometry
HSQC	Heteronuclear single quantum coherence
IC	Ion chromatography
LC	Liquid chromatography
LC/MS/MS	Liquid chromatography tandem mass spectrometry
LLE	Liquid-liquid extraction
LOD	Limit of detection
MRM	Multiple reaction monitoring
MS	Mass spectrometer/spectrometry
MSD	Mass selective detector
MWRDC	Metropolitan Water Reclamation District of Greater Chicago
NDMA	N-Nitrosodimethylamine
NHANES	National Health and Nutrition Examination Survey
NMOR	N-nitrosomorpholine
NMR	Nuclear magnetic resonance
NOM	Natural organic matter
PAHs	Polycyclic aromatic hydrocarbons
PCI	Positive chemical ionization
PI	Product ion
PPCPs	Pharmaceuticals and person care products

ppm	parts per million
QTOF	Quadrupole time-of-flight
RF	Radio frequency
SIM	Selected ion monitoring
SPE	Solid phase extraction
SRM	Single reaction monitoring
TD-NCI	Thermal desorption negative chemical ionization
THMs	Trihalomethanes
TOF	Time-of-Flight
U.S.	United States
UV	ultraviolet
WHO	World Health Organization

ABSTRACT

Environmental pollutants can be found in many ecosystems and cover many different compound classes. The Environmental Protection Agency is responsible for monitoring and regulating several of these classes of compounds which daily enter the environment. However, there are still hundreds, if not thousands, of compounds present in the environment which have yet to be regulated or even identified. The discovery and identification of these unknown emerging pollutants is crucial for the prevention of potential human health risks and irreversible ecological damage.

The research presented is divided into two projects. The first part of this research investigates the disinfectant 3-Bromo-1-chloro-5,5-dimethylhydantoin, which is often used in the treatment of hot tubs. Treating the water with this chemical is intended to protect the swimmer from harmful bacteria that may be present in the water. However, the reaction of the disinfectant with other organic compounds found in the water can lead to the formation of potentially toxic disinfection by-products. The use of thermal desorption negative chemical ionization time-of-flight mass spectrometry allows for a wider range of compounds to be ionized than conventional gas or liquid chromatography. The high resolution mass data were used to infer a molecular formula that could be used in database searches to find potential structural matches. The mass spectra indicated the presence of ions containing one and two bromine atoms.

The second study investigated the oxidation of the prevalent environmental contaminant triclosan. Triclosan is known to oxidize to form 2,4-dichlorophenol, which is carcinogenic and displays some estrogenic activity. While other oxidation products have been hypothesized, such as other dichlorophenols, none have been positively identified. Analysis of reactions of triclosan and hydrogen peroxide at high pH indicate the presence of three compounds that appear to all be dichlorophenols. One compound has been identified as 2,4-dichlorophenol. Additionally, 2,5-dichlorophenol and 3,4-dichlorophenol have been identified. A late eluting peak has fragmentation consistent with the dichlorophenols. However, it does not coelute with the dichlorophenol standards. This compound is hypothesized to be a semi-quinone. The effects of pH on the oxidation product profile of triclosan are also presented.

CHAPTER ONE

THE HISTORY OF WATER TREATMENT AND CURRENT CHALLENGES

Introduction

The earliest known methods of water treatment were simple filtration to remove particulates. Today, water treatment uses various chemicals and processes to enhance the aesthetic qualities and overall safety of drinking water as well as water treated and released to the environment. Treatment plants typically use some combination of the following processes, depending on the source water. Flocculation and sedimentation are employed to coagulate small, suspended particles present in source water to form larger particles which settle out of the water. Water may then be passed on to a filtration process which removes particulates and enhances the effectiveness of disinfection. Ion exchange processes can be used to remove metals such as arsenic and chromium, and other ions like nitrates. Adsorption techniques, such as those that use activated carbon, remove unwanted coloring, compounds causing adverse taste and odor, and other organic compounds. Finally disinfection, typically using chlorine, is employed to kill potentially dangerous microbes. Disinfection may also be done using chloramine, chlorine dioxide, ozone, UV radiation, or combinations of these methods. Water to be released to the environment may undergo an additional neutralization reaction to remove any residual disinfectant before release. The chemical

decontamination and disinfection of drinking water was a major public health improvement that was achieved at the beginning of the 20th century¹⁻⁴.

Sewer systems in metropolitan areas are designed to carry waste from homes and businesses to wastewater treatment plants that convert raw sewage (influent) into treated water, which can be released into rivers or other bodies of water (effluent). Combined sewer systems have “outflow” mechanisms that allow for sewer overflow (caused by excess rainwater accumulation) to empty into surface waters (rivers, streams, and lakes). These overflow events typically occur during or shortly after a rainstorm event. When overflow events occur, untreated raw sewage and wastewater from homes and businesses can bypass the water treatment process altogether and enter the aquatic environment directly. In the Chicago area, the combined sewer system has outflows spaced approximately every quarter to half mile, dependent on population density, along the Lake Michigan waterfront and the Calumet and Chicago Rivers (Figure 1)⁵.

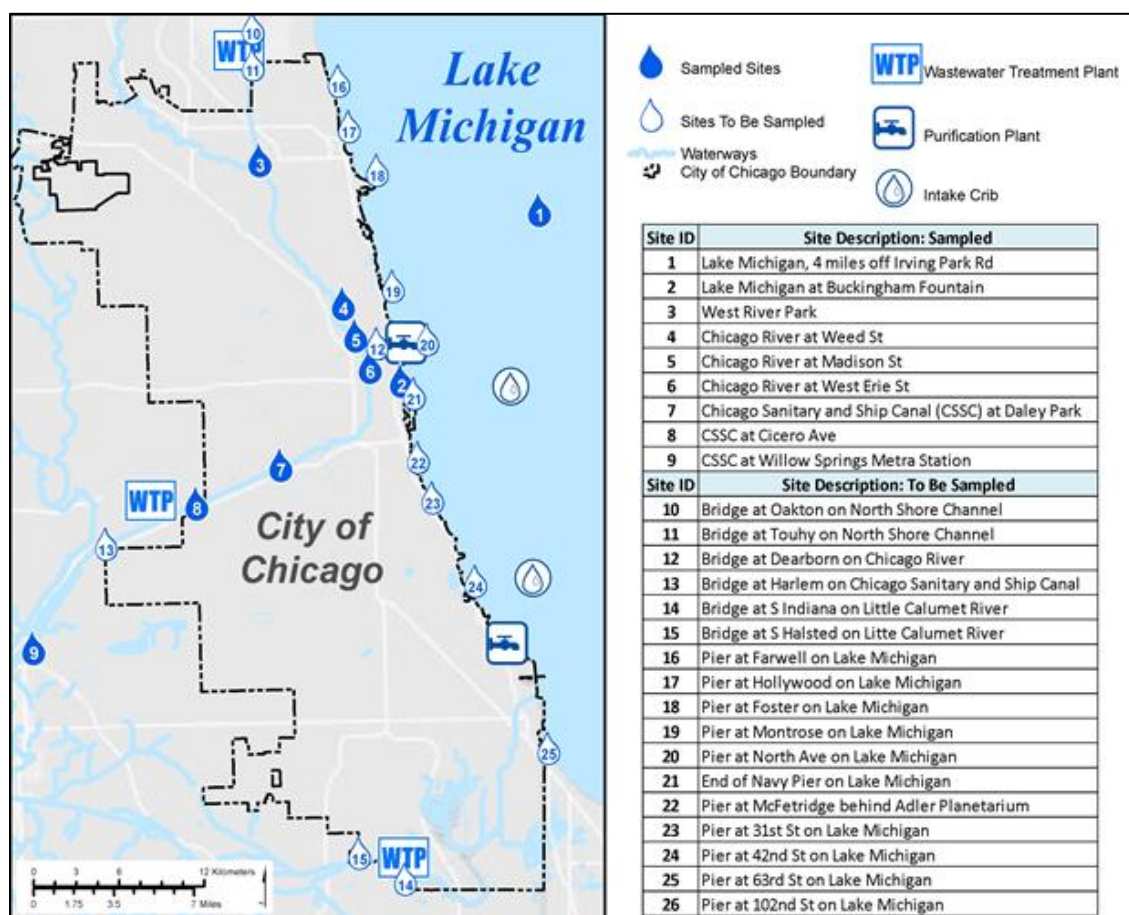

Figure 1. Map of Chicago area Lake Michigan shoreline and waterways with sampling points indicated by drops (CSSC = Chicago Sanitary and Ship Canal).

The City of Chicago obtains its drinking water mainly from Lake Michigan, so it is necessary to protect this body of water from sewage contamination resulting from overflow events. In the early part of the 20th century, the Army Corps of Engineers undertook a project to reverse the flow of the Chicago River to prevent raw sewage from entering Lake Michigan and contaminating the drinking water supply. This resulted initially in the creation of the Chicago Sanitary and Ship Canal which reversed the flow of the Chicago River causing it to flow into the Des Plaines River, the Illinois River and eventually into the Mississippi River and the Gulf of Mexico. After the opening of the

canal and in the years that followed its creation, the City of Chicago did see significant drops in the occurrence of illnesses caused by contaminated drinking water, such as cholera and typhoid. However, raw sewage still ended up in Lake Michigan after significant rainfall events causing waters to be polluted by raw sewage. As the population of Chicago grew, the system for water diversion from Lake Michigan to dilute the pollution found in the Chicago River eventually grew to include the North Shore Channel and the Calumet-Sag Channel, the latter of which reversed the flow of the Calumet River away from Lake Michigan into the Calumet-Sag Channel which connected with the Sanitary and Ship Canal. Finally, as technology developed and more was learned about the impacts of raw sewage in the environment, treatment plants were built along the canal systems to greatly reduce the amount of untreated sewage entering the environment. These treatment systems release effluent streams (treated sewage) which may contain industrial pollutants, pharmaceuticals, personal care products (soaps, shampoos, make-up, fragrances, etc.) as well as compounds created through the wastewater disinfection process which may be deleterious to the aquatic ecosystem⁶⁻⁸.

There have been more than 101 million unique organic and inorganic chemical substances registered with the Chemical Abstracts Service (CAS) since July 2015. Approximately fifteen thousand new substances are added daily. More than 68 million products are commercially available comprised from 30 million unique CAS Registry Numbers from over 880 suppliers⁹. The number of unregistered compounds (e.g. illicit drugs or non-patented or unpublished synthetic products) is unknown. Consequently,

the potential number of chemicals that may be entering the environment is simply astronomical. Studies investigating the prevalence of pharmaceuticals and personal care products (PPCPs) in the environment and other waters have revealed just how broad the exposure could be in addition to highlighting some of the potential detrimental effects exposure to these compounds can have on humans and wildlife¹⁰⁻¹⁵.

Environmental, waste and drinking waters are not the only systems susceptible to the influence of micro pollutants. Pools, hot tubs and other recreational and parks also disinfect water to ensure patron safety. These waters are treated similarly to others in that they undergo filtration and chemical treatment, like disinfection. The unique aspect to pools is that the water is recirculated and residual levels of disinfectant need to be maintained for effective disinfection. Utilization of pools not only introduce more organic compounds but also can reduce the levels of disinfectant if proper care is not taken in monitoring. The introduction of unknown organics and subsequent reaction with the disinfectant leads to the formation disinfection by-products (DBPs). These compounds can continue recirculating in the pool and in the treatment system, which, in turn, may form other variants on the already present DBPs^{16,17}.

Increasing global access to safe drinking water and sanitation has the potential to improve the quality of life of billions of people and greatly decrease cases of waterborne diseases that may result in death¹⁸. Thus, clean, safe water is essential for the survival of human life. As nations continue to develop, the threat of contamination to water sources essential for life are at an ever increasing risk from contaminants that enter the environment. While water treatment does significantly reduce the cause of

concern for disease transmission, as observed in more developed countries, water treatment techniques do unintentionally introduce potentially harmful disinfection by-products (DBPs) into the waters and other pollutants may not be fully removed. However, treatment processes are not the only contributor to water pollutants as there are many other possible sources of contamination (Figure 2)¹⁹⁻²².

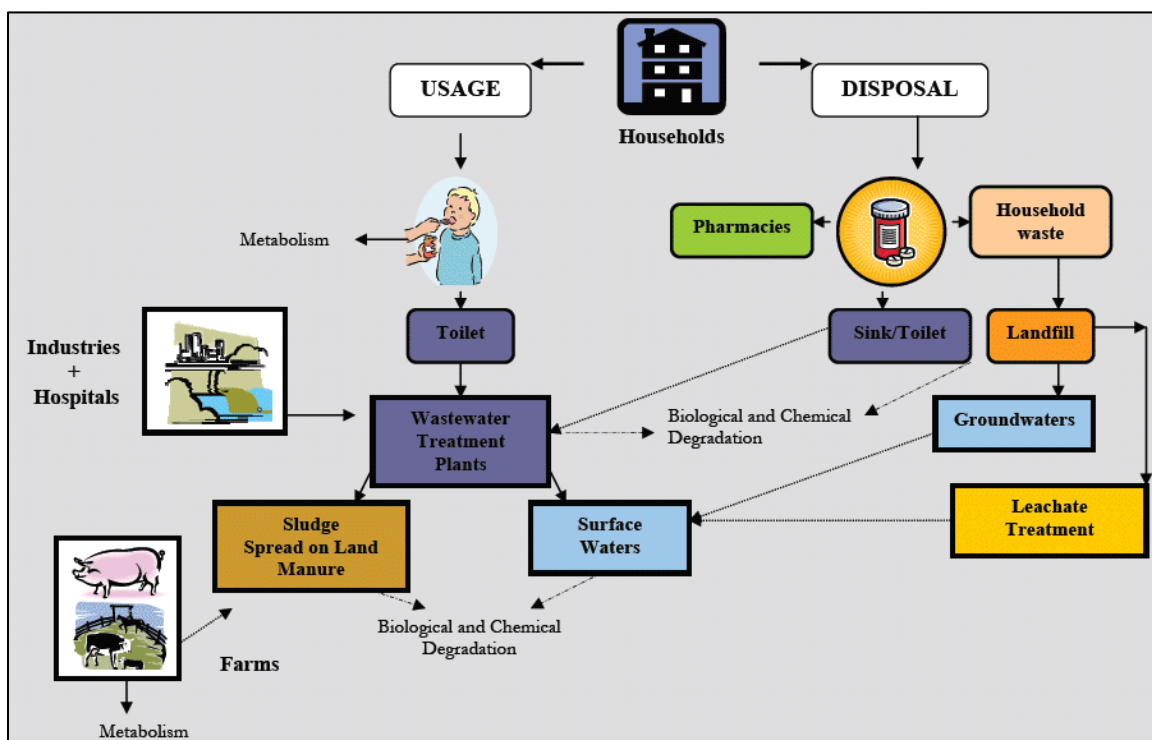

Figure 2. Sources of emerging contaminants²¹⁶.

Environmental contaminants coming from pharmaceuticals, personal care products, water disinfection, and other anthropogenic sources can be classified as emerging contaminants. Broadly defined, an emerging contaminant is a compound that has been detected in the environment for which no regular environmental monitoring is being carried out and no, or minimal, toxicological data exists²³. Due to structural similarities to known toxic substances, many emerging contaminants are suspected of

exerting adverse human and/or ecological effects. While water treatment has significantly reduced the transmission of waterborne disease, processes are not effective in removing many emerging pollutants in addition to being implicated in creating DBPs. Due to the variety of compound classes entering the treatment process and the lack of knowledge about the reactions that these compounds may undergo during the treatment process, it is difficult to optimize systems for the complete removal of all potential threats to human and environmental health and mitigate the risk of DBP formation. The World Health Organization (WHO), in a paper on the prevention of cancer²⁴, indicate that while water treatment is well designed to deal with the more immediate biological and specific chemical hazards, the number of different chemical classes that may be present in source waters may necessitate more specific and extensive treatment methodologies to fully remove all chemical hazards, especially those of carcinogenic nature. As little is known about the compounds, which may be entering the environment and their associated toxicity, it is imperative that researchers develop analytical methodologies to determine what new hazards, towards humans and the environment, may be lurking in our water. The following describes a selection of compound classes which may be found in the environment and the potential threats these chemicals may have on human and environmental health.

Pesticides

Pesticides are a broad class of compounds containing the likes of herbicides, insecticides, bactericides, and fungicides as examples. Due to their extensive worldwide use in agriculture and in the industrial emission during production, pesticides are a

major contributor to the growing number of pollutants found in surface waters. Though pesticides are found extensively in the environment, they are not considered emerging contaminants. There is a comprehensive knowledge of pesticides occurring in the environment, but information on their environmental transformation products is not as extensive, leading these to be classified as emerging contaminants²⁵.

Few studies have been conducted on the removal of pesticides from wastewater, but reports conclude an overall poor removal of most pesticides studied²⁶⁻²⁸. Instances have also been reported of treatment processes increasing the concentration of selected pesticides. While it is uncertain why pesticide concentrations may increase through the treatment process, it has been proposed that metabolized pesticides entering the treatment process may be deconjugated, either through hydrolysis or bacterial metabolism, leading to the free form being detected. Transformation products, hydrolysis, and desorption from particulate matter are also potential routes through which concentrations may increase during the treatment process²⁶.

Pesticides have been found in surface and ground waters across the United States (U.S.) increasing concern that, though regulated, pesticides pose a threat to human health through the water supply^{29,30}. In fact, instances of drinking water contamination by pesticides leading to human ingestion have been reported^{31,32}. While the levels of pesticides observed in ground waters typically do not exceed levels established by the U.S. Environmental Protection Agency (EPA) for the protection of human health, levels observed in surface waters were sufficiently high to be of

significance to aquatic life and the surrounding ecosystem. Additionally some pesticides, specifically organochlorine compounds, are known to persist in the environment^{29,30}. A survey of U.S. streams and rivers conducted from 1992-2011³³ found atrazine to be present in at least 75% of the samples analyzed. Metolachlor was found in at least 55% of the samples analyzed. These two compounds are mono-chlorinated herbicides. Variation in detection frequency was observed based on land use. Mean concentrations observed in U.S. freshwaters for atrazine is 2.4 µg/L with a maximum observed concentration of 201 µg/L. The mean observed concentration for metolachlor is 1.2 µg/L with a maximum concentration of 77.6 µg/L³⁴.

The full impact of pesticides on human health may not be fully realized as some exposure symptoms may be incorrectly linked to other causes. However, pesticides have been linked with increased risk of various cancers, chloracne, porphyria, and neuropathy in humans³⁵. Studies of human exposure to pesticides via contaminated well water indicated the possibility of transient liver injuries related to the pesticide exposure as well³¹.

Polycyclic Aromatic Hydrocarbons

Polycyclic aromatic hydrocarbons (PAHs) are a class of organic compounds consisting of two or more fused benzene rings often resulting from incomplete combustion of materials such as oil, petroleum, gas, coal, and wood^{36,37}. PAHs are of concern due to their carcinogenic and mutagenic properties. Links to an increased risk of lung and bladder cancer have been associated with occupational PAH exposure³⁸.

The presence of PAHs in the aquatic environment and in water treatment plants has been known since the 1970s³⁹. However, minimal research has been conducted on the effectiveness of PAH removal during the treatment process. A study published in 2013 investigating the removal efficiency of 16 PAHs in drinking water concluded that, while PAH levels were below regulated levels, there was an overall increase in total PAH concentration during the drinking water treatment process⁴⁰.

Polycyclic aromatic hydrocarbons pose numerous health risks to aquatic species. The complex mixture of PAHs that is present in the environment makes assessing individual toxicity and exposure difficult. However, this does not prevent the utilization of single compounds to be used as models in assessing potential toxicity to aquatic species. Furthermore, as PAHs are lipophilic, these compounds are known to accumulate in tissue, leading to the exposure of higher order organisms and the risk of other potential detrimental health effects in species further up the food chain. Sea bream, a fish species found in the Atlantic and Mediterranean, has been used in acute exposure studies using benzo[a]pyrene. At a dose of 2 mg/L and exposure for 12 to 72 hours, sea bream exhibited not only accumulation of benzo[a]pyrene but also morphological changes, inflammatory responses, and induced cytochrome P450 1A activity in the gills, liver, and muscle⁴¹. Benzo[a]pyrene has also demonstrated an ability to induce aldehyde reductase in tilapia. However, whether this induces any toxic effects is as of yet unknown⁴². Fluorene, phenanthrene and pyrene have been investigated for the individual as well as combined effects on sea bream as well. Compounds were dosed at concentrations ranging from 5 to 200 µg/L. As observed in other studies, the single

PAHs accumulated in the muscle in a manner consistent with the dose the fish was exposed to, i.e. the higher the dose the more the PAH accumulated in the fish tissue. A decrease in swimming and an overall increase in the number of immobilized fish were observed, which correlated to the exposure dose. The same trends were observed for the above measures when using a mixture of the three PAHs⁴³.

Metabolites of PAHs lead to different toxic effects in aquatic species as well. A flatfish species (*Limanda limanda*) was collected from two areas of the Seine Estuary in France. The collected fish were separated into respective groups based on sex and age (juvenile and adult). The induction of cytochrome P450 1A was assessed by using an activity assay of the liver enzyme 7-ethoxyresorufin-O-deethylase (EROD). Differences were observed between male and female fish as well as juvenile and adult. The comet assay, used to assess DNA strand breakage, allowed for the differentiation of seasonal variation at each site as well as between the two sites. Trends were observed between PAH-hydroxylated metabolite concentration and the comet assay. Higher metabolite concentrations resulted in a greater prevalence of DNA strand breakage⁴⁴. Oxygenated PAH metabolites (specifically anthracene-9,10-dione, benz[a]anthracene-7,12-dione, and 9,10-dihydrobenzo[a]pyrene-7-(8H)-one) were compared to their parent PAHs (anthracene, benz[a]anthracene, and benzo[a]pyrene) for hepatic fatty acid β -oxidation in chicken embryos. A reduction in hepatic β -oxidation was observed after exposure to all three PAHs at once. A combination of the three PAH metabolites resulted in an increase in hepatic β -oxidation. Further investigation into the cause of this result implicated exposure to the metabolite of benzo[a]pyrene, 9,10-dihydrobenzo[a]pyrene-

7-(8H)-one, as the causative agent. This preliminary study into avian exposure to PAH metabolites has opened the door to future studies into more extensive risk assessment studies related to PAHs and their associated metabolites⁴⁵. Malmquist et al.⁴⁶ proposed that metabolites of alkyl-PAHs, primarily polycyclic aromatic acids, may present a new class of contaminants that needs further investigation towards ecological risk assessment. The effects of PAHs are routinely extrapolated from test compounds. However, organisms are never exposed to a single PAH but rather to a complex cocktail, which may have different effects than the individual components. While the toxicity of various PAHs are known, the unknown risks of these PAH mixtures as well as the introduction of PAH metabolites as potential risk factors open other avenues for further study.

Disinfection By-Products

Disinfectants such as chlorine, chloramine, ozone, and chlorine dioxide are strong oxidizing agents employed in the treatment process for reducing the populations of harmful bacteria as well as for oxidizing anthropogenic matter. Disinfectants though do unintentionally create by-products, referred to as disinfection by-products or DBPs, which have become recognized as emerging environmental contaminants^{47,48}. DBPs have been known to persist in the water since the mid-1970s when trihalomethanes (THMs) (Figure 3) were first identified in the water supply⁴⁹. Research into DBPs through laboratory scale experiments in which disinfectants were reacted with natural organic matter (NOM) present in water or direct analysis of drinking water has led to the identification of at least 600 DBPs, which may be found in drinking water. The number

of potential DBPs is only expected to increase as newer disinfection and water treatment processes are implemented⁵⁰⁻⁵⁵.

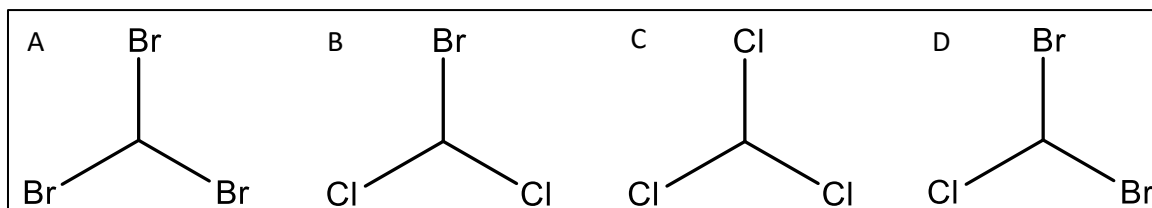

Figure 3. Structures of the four EPA regulated THMs: (A) bromoform, (B) bromodichloromethane, (C) chloroform, and (D) dibromochloromethane.

The creation of these DBPs would in itself not be a major concern if the created compounds were benign. However, it is known that THMs do cause cancer in laboratory test animals and thus could present a serious health risk to humans^{13,56}. A study conducted by Villanueva et al.¹⁴ concluded that male humans exposed to an average of more than 1 µg/L THMs are at an increased risk to bladder cancer compared to those with lower to no exposure to THMs. Comparatively, among THM exposed women, there was no observed associated risk to an increased risk of bladder cancer¹⁴. Other targets of potential negative health outcomes investigated have included selected birth defects (neural tube defects, heart defects, and orofacial clefts). However, in their research, Shaw et al.⁵⁷ did not observe any obvious patterns associated with THM exposure and the selected malformations.

THMs have been extensively researched. However, other halogenated DBPs with proposed toxicity have begun to be identified in various aqueous media. Zhao et al.⁴⁸ characterized and identified 2,6-dichloro-1,4-benzoquinone, 2,6-dichloro-3-methyl-1,4-benzoquinone, 2,3,6-trichloro-1,4-benzoquinone, and 2,6-dibromo-1,4-benzoquinone

(Figure 4), all suspected bladder carcinogens, in drinking water using high pressure liquid chromatography (HPLC) coupled to a hybrid quadrupole time-of-flight (QTOF) mass spectrometer (MS). In another study, Zhao et al.⁵⁸ investigated the presence of 8 halobenzoquinones in nine drinking water plants across the U.S. and Canada using liquid chromatography tandem mass spectrometry (LC/MS/MS). Of the eight investigated compounds, four were detected and two, 2,6-dichloro-1,4-benzoquinone and 2,6-dibromo-1,4-benzoquinone, were detected in over half of the samples collected. More recently, Zhang et al.⁵⁹ utilized ultrahigh resolution mass spectrometry (Fourier transform ion cyclotron resonance mass spectrometry) to determine formulas for 441 monobrominated and 37 dibrominated DBPs in simulated drinking water samples following treatment with chlorine. However, none of these compounds have yet been identified.

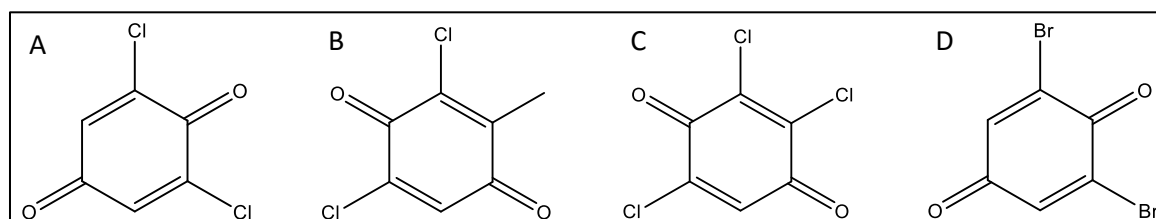

Figure 4. Structures of (A) 2,6-dichloro-1,4-benzoquinone, (B) 2,6-dichloro-3-methyl-1,4-benzoquinone, (C) 2,3,6-trichloro-1,4-benzoquinone, and (D) 2,6-dibromo-1,4-benzoquinone.

With many emerging contaminants, particularly DBPs, studies investigating the toxicity of any given compound are lacking. In those studies that do investigate particular compounds, it is unclear what kind of an effect the many other compounds found in the drinking water matrix may have on the overall toxicity, i.e. toxicity which is additive, synergistic or antagonistic. Regardless of the complexity of the matrix and

various interactions, looking at individual component toxicity does present a potential threat. What is understood among halogenated DBPs, though, is toxicity appears to increase when going down the period; chlorinated compounds are generally least toxic followed by brominated, and finally iodinated compounds being the most toxic^{50,60}.

Drinking water, though, is not the only matrix in which DBPs, or emerging contaminants for that matter, can be found. As pools and hot tubs are also disinfected, a vital part of pool care for the mitigation of microbial contamination, many DBPs can be found in these matrices as well. The commonly observed haloacetic acids (HAAs) (Figure 5), particularly di- and tri- chloroacetic acids, as well the THMs chloroform and bromoform were dominant species found^{61,62}. The prevalence of brominated or chlorinated species present is dependent on the chemicals used for disinfection, i.e. chlorinated species dominated with chlorinating agents and brominated species dominated with brominating agents⁶². Richardson et al.⁶³ undertook an extensive identification of DBPs in pool waters, which were either treated with chlorinating or brominating agents, using gas chromatography mass spectrometry (GC/MS). A number of other haloacids, such as 3-bromopropenoic acid and trichloropropenoic acid, were observed in addition to the other common HAAs. A selection of haloaldehydes, halonitriles, haloketones, a few nonhalogenated DBPs, and several other DBPs from other compound classes were tentatively identified with some identities being confirmed through authentication with standards.

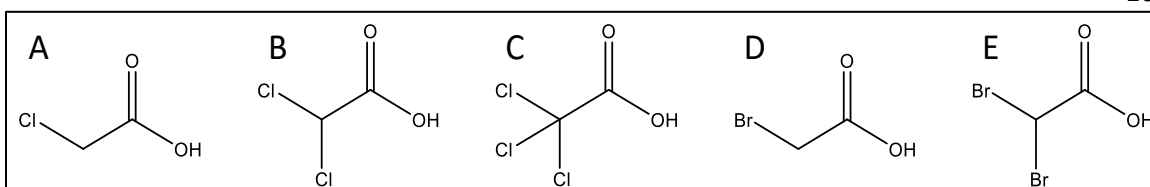

Figure 5. Structures of the five EPA regulated HAAs: (A) chloroacetic acid, (B) dichloroacetic acid, (C) trichloroacetic acid, (D) bromoacetic acid, and (E) dibromoacetic acid.

Exposure to DBPs in aquatic park environments does not necessarily occur through ingestion of water as it does with DBPs in drinking water. Xiao et al.⁶⁴ found that 2,4-dibromophenol, 2,4-dichlorophenol and 2-bromophenol were permeable at rates of 0.031, 0.021, and 0.023 cm/hr with skin being 2-3 mm thick on average. The interaction of disinfectants with the skin also lead to the formation of DBPs.

Chloroform, a known carcinogen⁵⁶, has been observed at elevated levels in the blood of swimmers and is attributed to both the presence of chloroform in the pool water as well as the air in indoor pool environments⁶⁵. Kogevinas et al.⁶⁶ found that the total concentration of four THMs (chloroform, bromoform, bromodichloromethane, and chlorodibromomethane) in exhaled breath was approximately 7 times higher in swimmers than before swimming. Participants in this study also contributed urine samples to investigate mutagenicity. A compound is a mutagen if it induces a change, either directly or indirectly, in DNA which can be inherited. Genotoxic compounds are mutagens as well, but the changes in the DNA lead to cell death or mutations^{67,68}. It was found that urine mutagenicity increased significantly and was associated with increased concentrations of bromoform⁶⁶. These findings support the potential genotoxic effects of exposure to DBPs such as the reported higher risk of bladder cancer.

Links have been observed between swimming and DBP exposure and conditions such as respiratory ailments (like asthma), allergies, and dermatological conditions (like eczema). However, these links may be tenuous at best as the relations have not been consistently observed across studies investigating DBPs and swimming and the potential health effects⁶⁹. It is generally accepted, though, that pool waters do have a degree of non-specific toxicity. Assessments toward more specific toxicological endpoints (such as genotoxicity and mutagenicity) have resulted in mixed results. Comparisons of genotoxicity between tap water presumably used to fill pools and the pool water itself found in some instances an increased genotoxicity of pool water. However, differences in genotoxicity of waters exist dependent on the disinfectant used. Comparisons for mutagenicity found little to no difference between tap water and treated pool water^{61,63,70}.

Pharmaceuticals and Personal Care Products

Pharmaceuticals and personal care products began to garner more attention in the late 1990s and early 2000s after reports came out about the prevalence of PPCPs in surface waters^{15,71}. Since that time, a number of pharmaceuticals have been consistently observed in the environment. Studies investigating different sources of water (surface, waste water influent and effluent, drinking water) have reported detectable levels of ibuprofen, aspirin, diclofenac, diazepam, estradiol and other synthetic steroids, erythromycin, and sulfamethoxazole, as examples⁷²⁻⁷⁵. Seasonal variations in concentrations of PPCPs, and other emerging contaminants, have been observed^{75,76}.

While these products are designed to enhance human health, they pose an ecological threat. Improper disposal of household pharmaceuticals is the primary pathway of environmental contamination. This problem is particularly acute in hospitals⁷⁷⁻⁸⁰. Anti-inflammatory drugs, such as ibuprofen, which can lead to cardio abnormalities in species, are commonly observed in the environment. Antidepressants, antifungals, beta blockers, and an array of antibiotics have also been observed and linked to various deleterious effects on aquatic life, including decreased growth and other developmental abnormalities (fathead minnows, medaka, and rainbow trout), lower sperm counts (fathead minnows), and suppressed immune systems (rainbow trout)⁸¹. The release of antibiotics to the environment is also believed to contribute to increased antibiotic resistance⁸².

Among the most highly prescribed pharmaceuticals are benzodiazepines, such as diazepam, which have also been among the more extensively studied pharmaceuticals in environmental and waste waters. Calisto and Esteves⁸³, in their review of pharmaceuticals in the environment used to treat mental health disorders, found concentrations of diazepam to be as high as 1.18 µg/L in waste water influent of a sewage treatment plant in Belgium. A municipal sewage treatment plant in Germany had concentrations in the effluent that were significantly less with maximum concentrations reported around 0.053 µg/L. Surface waters had concentrations up to 0.88 µg/L were found in Germany, and diazepam concentrations up to 23.5 ng/L were observed in Italy⁸³. Despite the global presence of diazepam in the environment, toxicity studies have only investigated acute effects on aquatic organisms. To observe acute

effects, concentrations of diazepam were found to be significantly higher than even the highest concentration found in surface waters. Diazepam may have effects on the nervous system of fish and has been observed to inhibit polyp regeneration in *Hydra vulgaris*, a fresh water invertebrate⁸⁴.

Pedrouzo et al.⁸⁵ have studied river and tap water and waste water influent for the presence of macrolides, sulfonamides, and other pharmaceuticals using liquid chromatography coupled to an ion trap mass spectrometer. Of the compounds observed in river water from the Ebro, Ter and Llobregat rivers in Spain, sulfamethoxazole, an antibiotic used to treat bacterial infections such as urinary tract infections, had the highest concentration (50 ng/L). Sewage treatment plants in the Tarragona region of Spain with a maximum concentration of 0.24 µg/L Ranitidine, which is used to treat heartburn and other stomach maladies, was most frequently detected in waste water influent. Ranitidine and sulfamethoxazole have also been observed in influent wastewater samples between 20 and 2,175 ng/L and 453 and 5,695 ng/L respectively⁸⁶. Ranitidine is not considered harmful for aquatic organisms due to its high LC₅₀ (> 100 mg/L). However, the H₂- and histamine receptors with which the drug acts on in human gastrointestinal systems, are also present in the brain. Thus, an adverse central nervous system reaction or other side effects may be possible. Additionally, aquatic species have been found to have similar receptors, so it is possible that ranitidine may act on aquatic species as well. The effects of ranitidine on aquatic species have not been fully investigated though⁸⁴. Similarly, sulfamethoxazole concentrations up to 100 µg/L do not appear to show any acute or chronic toxicity effects on several

aquatic species that are used as test subjects. Inhibition of algae growth in the presence of sulfamethoxazole and other pharmaceuticals is possible, indicating singular toxicity studies are not sufficient to fully determine the effects pharmaceuticals, or other emerging contaminants, may have on aquatic species⁸⁷.

Most pharmaceutical metabolites are known to be biologically inactive. However, metabolic processes, such as glucuronidation and sulfonation, increase the water solubility of many pharmaceuticals, thus enabling them to spread throughout the environment more extensively than the parent molecule itself. As a result, metabolites such as these have been suggested to pose a greater ecological threat than the parent molecule. Those metabolites, which are biologically active, such as retinoid glucuronides and morphine-6-glucuronide could easily pose a threat to the aquatic environment⁸⁸.

Pharmaceuticals and other xenobiotic compounds are eliminated from the human body through a series of reactions commonly called Phase I and Phase II metabolism or biotransformation. Phase I and II enzyme-catalyzed chemical reactions modify the structure of the substrate to species that is large, carries a charge, and is more hydrophilic allowing for the elimination of the xenobiotic in urine or feces. Phase I biotransformation is the hydrolysis, reduction, or oxidation of the xenobiotic to either expose or introduce a functional group (-OH, -NH₂, -SH, or -COOH), which slightly increases the hydrophilicity (Scheme 1). Phase II reactions are acetylation, methylation, and reactions that conjugate glucuronides, sulfates, glutathione, or amino acids to the xenobiotic (Scheme 2). The addition of these moieties greatly increases the hydrophilicity leading to their elimination from the body^{67,68}.

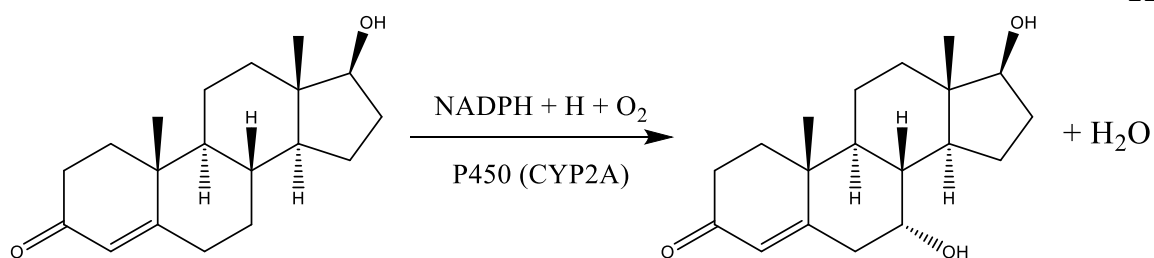

Scheme 1. Phase I biotransformation of testosterone by hydroxylation.

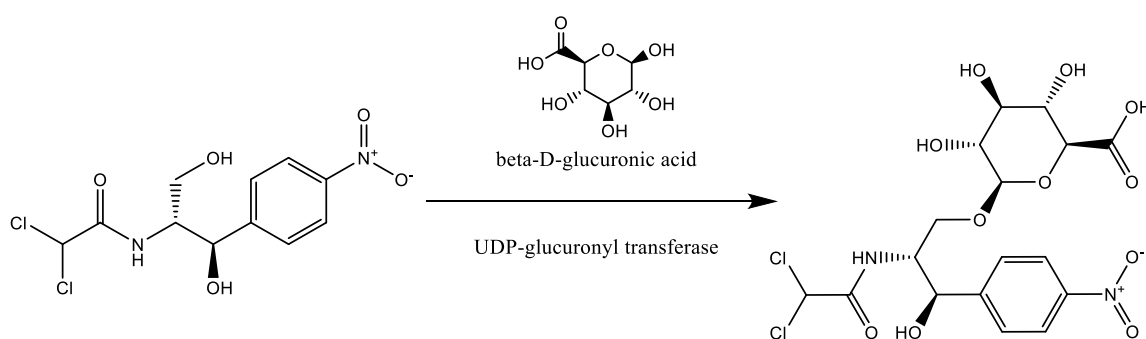

Scheme 2. Phase II glucuronidation of the antibiotic chloramphenicol.

The first metabolites reported in aqueous matrices, such as waste water effluent, were those of clofibrate and aspirin in 1977⁸⁹. These two drugs undergo Phase I metabolism in the liver resulting in the formation of the hydrolysis products clofibric acid and salicylic acid⁹⁰ which were the identified metabolites. Since that time, a number of other pharmaceutical metabolites have been reported in surface and waste waters. Ferrer and Thurman⁹¹ identified the Phase II glucuronide metabolite of the antidepressant lamotrigine in surface water samples from nine different states (Alabama, Colorado, Kansas, Nebraska, Ohio, New York, Minnesota, Texas, and Utah) at a median concentration of 195 ng/L using LC-QTOF-MS. While less toxic than the parent compound, the glucuronide metabolite can undergo hydrolysis in the environment back

to lamotrigine. A suite of illicit drugs (amphetamine, methamphetamine, morphine, cocaine, and methadone as examples) and the common Phase I or Phase II metabolites (norcocaine, morphine-3 β -D-glucuronide, and 11-nor-9-carboxy- Δ 9-tetrahydrocannabinol as examples) have also been observed in both influent and effluent wastewater coming from treatment plants in Italy and Switzerland²¹. Sunkara and Wells⁹² identified the Phase II sulfate metabolite of acetaminophen and the Phase I metabolite p-aminophenol using LC/MS/MS. Only the sulfate metabolite was reliably quantified at a concentration around 33 μ g/L. As possible with glucuronides, the sulfate moiety can be lost resulting in the free parent molecule being present in the environment. Five Phase I metabolites of carbamazepine, an anti-epileptic, were found at concentrations between 15-1100 ng/L in both treated and untreated waste waters obtained from a waste water treatment plant in Peterborough, ON, Canada which services about 75,000 people. As with many of these metabolites, actual toxicity data are limited. However, the potential for adverse environmental effects may be amplified through greater water solubility of these compounds⁹³.

Phenol Derivatives

Phenolic compounds come from a variety of consumer products and industrial sources, some of which have been discussed. Chlorophenols have been used in industry as wood preservatives, intermediates for pesticides, and as home and industrial disinfectants. Phenolic compounds can also be found in sunscreens, perfumes and other personal care products. Further chlorinated derivatives of phenolic compounds may be the result of the disinfection process for water treatment^{94,95}. A number of other

halogenated phenol derivatives have historically been used in clothing, furniture, and drapery as flame retardants⁹⁶. Of the many compounds that can be classified as phenolic, triclosan (5-chloro-2-(2,4-dichlorophenoxy)phenol) and bisphenol A (BPA or 2,2-bis(4-hydroxyphenyl)propane) have been studied for their environmental persistence and links to negative health effects in both animals and humans and are here discussed.

BPA is used commonly in the manufacture of plastics, specifically polyester-styrene and polycarbonate plastics used in food and beverage packaging. BPA has also found uses in dental sealants and fillings, adhesives, protective coatings, epoxy resins, flame retardants, water supply pipes, and even compact discs⁹⁷. Environmental and human exposure to BPA comes from the estimated one million pounds which is released to the environment annually. In addition to the exposure to BPA from the environment, humans are exposed to BPA as it leaches out from plastic food containers and other food contact surfaces which contain BPA⁹⁸.

Studies investigating the impact of BPA on aquatic species have concluded that there are a number of detrimental outcomes which may result. In a review by Kang et al.⁹⁹ the concentration of BPA in surface waters was reported to be 8 µg/L or less across the United States, Germany, Japan, Spain, the Netherlands, and China. The review of the literature also indicate that BPA is an endocrine disruptor, which leads to vitellogenin induction as observed in zebrafish and other species, embryonic deformities and a reduction in the number of eggs and hatchlings observed with medaka, a lower sperm density and motility seen in brown trout, decreases in total sperm counts in guppies, a

reduction in testosterone and an induction of estron in turbot, and an induction of feminization in African clawed frogs as examples⁹⁹. However, some of these studies were conducted at concentrations of BPA that would not be considered environmentally relevant.

In their review on BPA and endocrine disruption, Vandenberg et al.⁹⁸ highlighted several ways by which BPA is known or suspected to interact in the human body. BPA is classified as a weak environmental estrogen as demonstrated through *in vitro* assays. The affinity for BPA to estrogen receptors alpha and beta, though, is approximately 10,000-fold less than that for naturally occurring estradiol¹⁰⁰. BPA may also bind with various other steroid receptors present in the human body and at BPA concentrations much lower than is needed to induce a response by binding to the estrogen receptors. The effects of BPA on the human body are further complicated with an affinity to the thyroid hormone receptor causing BPA to act as an antagonist preventing the binding of T₃, a thyroid hormone involved in a number of physiological processes. Other reviewed activities of BPA include anti-androgenic properties, binding to the aryl hydrocarbon receptor, and binding to the estrogen-related receptor- γ ^{98,101}.

Yoshino et al.¹⁰² investigated the effect of prenatal exposure to BPA on the immune response of mice. In this study, the female mice were fed varying doses of BPA for 18 days prior to being paired with a male. Tests measuring both T helper 1 and T helper 2 immune responses indicated an increased response of those mice prenatally exposed to BPA. The researchers concluded that this suggests prenatal exposure to BPA may result in an up-regulation of the immune responses in adulthood. The immune up-

regulation, it was further hypothesized, could occur either through prenatal or postnatal exposure to environmental endocrine mimics.

Various studies have correlated increased levels of BPA exposure to adverse human health effects. Lang et al.¹⁰³ utilized data from the 2003-2004 National Health and Nutrition Examination Survey (NHANES) to find if any correlations existed between BPA exposure and health outcomes such as chronic disease diagnosis, blood markers of liver function, glucose homeostasis, inflammation, and lipid changes. It was found that in the adult population surveyed the higher urinary BPA concentrations were correlated to an increased prevalence of diabetes, cardiovascular disease and liver enzyme abnormalities. In a similar investigation, Melzer et al.¹⁰⁴ used NHANES data from the 2003-2004 and 2005-2006 surveys. It was found that there was a correlation with high BPA exposure and the prevalence of heart disease. Correlations to a higher prevalence of diabetes or abnormalities and BPA exposure were not observed in the 2005-2006 survey data. However, correlations to these negative health outcomes were present in the pooled data sets. NHANES data have also been used to demonstrate a correlation to an increased risk of obesity¹⁰⁵.

Triclosan is an antimicrobial used in personal care products such as antibacterial soaps, toothpastes, skin creams, and deodorants. Triclosan has also found wide use in the medical setting due to its mildness and efficacy against a broad spectrum of bacteria^{106,107}. The primary route of entry of triclosan into the environment is through the sewage system as it is washed off the human body and goes down the drain.

Unfortunately, water treatment systems do not fully remove/breakdown triclosan. A

survey of 139 streams across 30 states found that triclosan was among the most frequently detected compounds⁷¹. A review of the occurrence of triclosan globally found levels up to 5.37 µg/L in effluent streams being released into the environment. The same review identified a maximum concentration of triclosan in influent streams of 86.2 µg/L. Triclosan was found up to 1.33 µg/L in river and lake sediment, and concentrations reached a maximum of 0.48 µg/L in lake and river waters¹⁰⁸.

Triclosan is generally accepted as safe for humans as there are no known negative health effects. The available data from animal testing is diverse across mammals and other test species as to prevent correlations to possible human toxicity difficult at best¹⁰⁹. Aquatic species experience a variety of effects from triclosan dependent on exposure time and species. Many of the observed effects are at concentrations that could be considered not environmentally relevant. Mortality, decreases in swimming speed, and embryo mortality, among other effects, were observed in several fish species at concentrations over 50 µg/L. Plant species and other lower order organisms experienced growth inhibition, changes in growth rate, and inhibition of photosynthesis, among other results, which were observed at concentrations under 10 µg/L¹⁰⁸. The effects of triclosan on lower order organisms could have lasting effects up the food chain leading to changes in the ecosystems.

Triclosan may be considered safe, but 2,4-dichlorophenol, a by-product of triclosan, is known to be carcinogenic as well as display some estrogenic activity^{110,111}. Triclosan breaks down via cleavage of the ether linkage leading to the formation of 2,4-dichlorophenol and 4-chlorocatechol in the water treatment process and in the

environment (Scheme 3)^{108,112,113}. The formation of 2,4-dichlorophenol has been demonstrated in the lab via oxidation using TiO₂ and ultraviolet light. This oxidation process also generated other, unidentified dichlorophenols coming from the cleavage of reaction intermediates¹¹⁴. Exposure to 2,4-dichlorophenol via water is known and assumed to be minimal via drinking water as it is regulated by the EPA¹¹⁵. Individuals may also be exposed to triclosan through personal care products where it is unknown how it reacts either in formulation or with use. It is unknown if or how triclosan reacts in product formulations or through use and if this could be an exposure route to compounds with known human toxicity, such as 2,4-dichlorophenol.

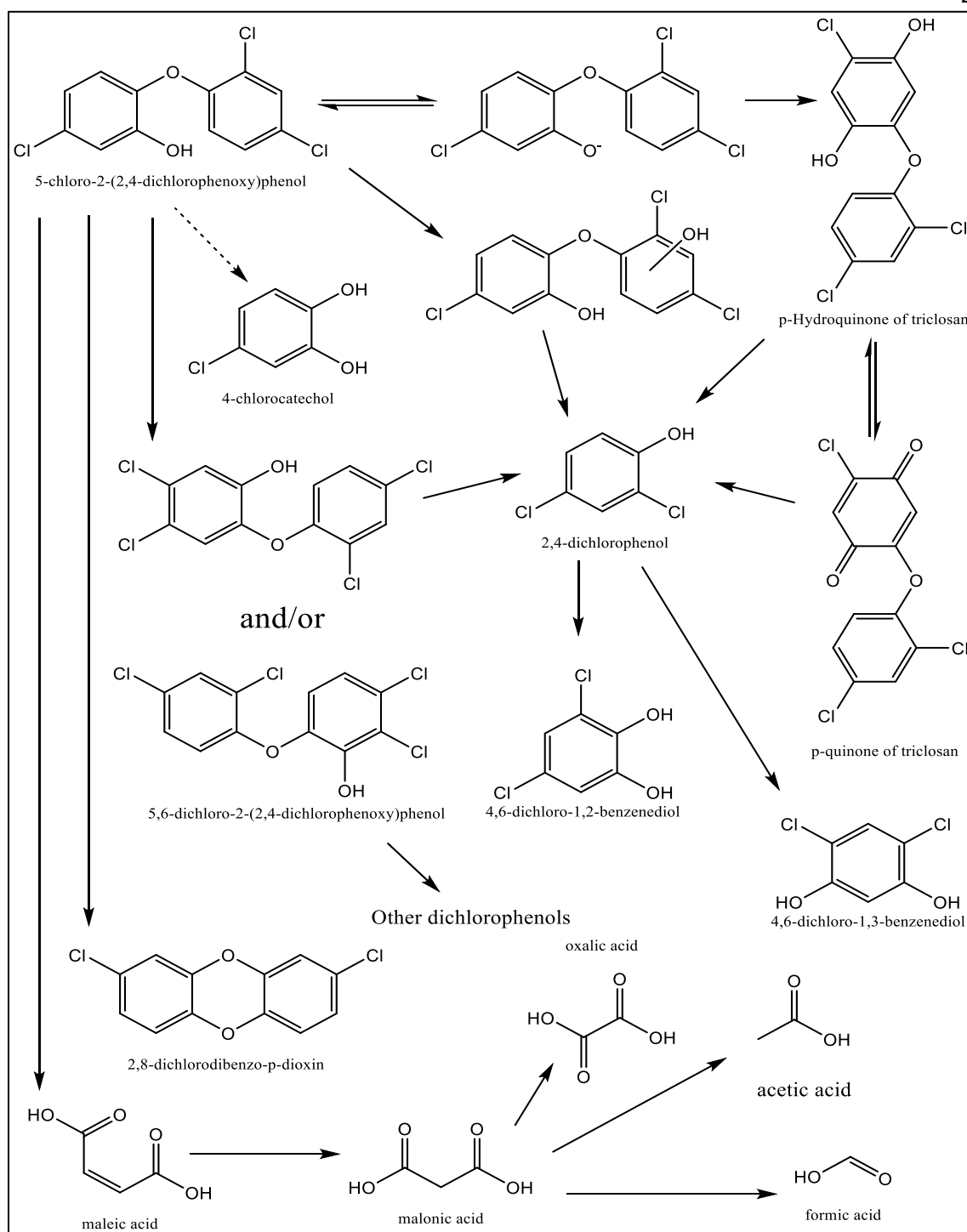

Scheme 3. Proposed pathways for the degradation of triclosan in the environment and advanced oxidation water treatment processes (modified and adapted from 113, 114, 116).

CHAPTER TWO

METHODS FOR THE ANALYSIS OF EMERGING CONTAMINANTS

Introduction

Mass spectrometry (MS) is the most widely used method through which compounds are identified and quantified in the study of emerging contaminants. Other methods may be utilized to supplement MS allowing for further compound characterization, but the ability of MS instrumentation to provide mass data is seen as an absolute necessity toward the identification of unknowns. Further, MS instrumentation can provide fragmentation patterns that are utilized for the quantification of compounds. However, not all MS instruments are equal. Selected ionization sources, mass analyzers, and detectors for mass spectrometry will be discussed in addition to other instrumental methods of analysis as they relate to emerging contaminant analysis.

Ionization Sources

The mode of sample ionization is an important consideration for sample analysis as it relates to mass spectrometry. For the mass of an ion to be determined, it must be charged. While neutral species may be detected, it is through the indirect means of detecting a charged fragment ion. Presented are several methods of ionization covering both hard and soft ionization techniques. The common electron ionization and

electrospray ionization techniques are presented along with several less common methods of sample ionization.

Electron Ionization

Electron ionization (EI) is among the most common method of sample ionization for the general organic mass spectrometry. The electrons used for sample ionization are generated from a heated filament, collimated, and then accelerated between electrodes to 70 eV. These electrons collide with the analyte stream, knocking an electron off the molecules present to generate positive ions. Approximately 7-12 eV is required for the formation of this ion with the remainder of the energy being used for further fragmentation of the molecules. EI is referred to as a hard ionization technique¹¹⁷.

Electrospray Ionization

Electrospray ionization (ESI) is used when liquid chromatography is interfaced to mass detection. ESI is a soft ionization technique because the analyte remains largely intact and very few fragment, if any, ions are produced. The formation of ions occurs over the course of several steps. The liquid sample is delivered to a nebulizer which generates charged droplets of the sample in an electric field of five to 10 kV/cm. The sample is introduced into a heated stream of a gas, typically nitrogen used for desolvation. During this process, the solvent shell is evaporated away concentrating the charge. The charge density will reach a point where the droplet will undergo a coulombic explosion leading to additional, smaller droplets being generated. This

process is repeated a number of times which leads to the analyte being present in a quasi-gas state (Figure 6)^{117,118}.

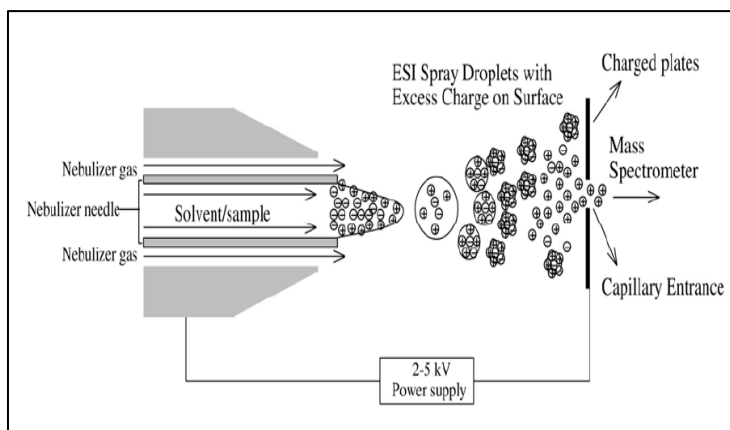
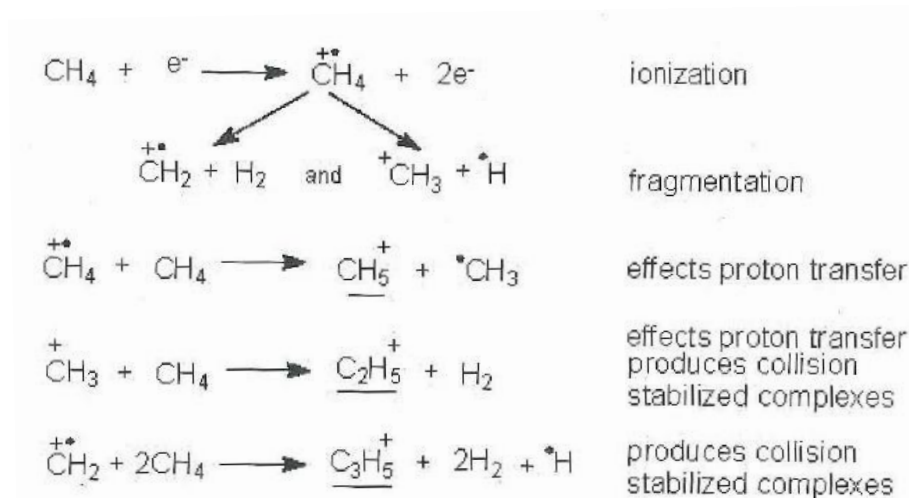

Figure 6. Schematic of electrospray ionization¹¹⁹.

Positive Chemical Ionization

The source for positive chemical ionization (PCI) is similar to that for electron ionization. Electrons are again generated from a heated filament and accelerated into the ionization source at energies greater than the 70 eV created in electron impact. In the source, a reagent gas, commonly methane, reacts with the electrons to form positively charged stable ions of the reagent gas (Scheme 4). These reagent gas ions react with the analyte leading to the formation either protonated molecular ions or positively charged molecule/reagent gas adducts¹¹⁸.



Scheme 4. Reactions for the ionization of the reagent gas in positive chemical ionization¹¹⁸.

Thermal Desorption Negative Chemical Ionization

Thermal desorption negative chemical ionization (TD-NCI) is sensitive for the detection of halogens and other compounds that have electron withdrawing groups. Thermal desorption, while poor for chromatographic resolution, makes accessible a wider range of compounds that may not easily be detected using EI due to the presence of conjugation or other features that generally ionize with greater difficulty or using ESI as the compound may lack functional groups amenable to ESI application. The sample, which is applied to a solids probe, is volatilized via a temperature gradient. Electrons, generated from a heated filament, enter the source and are thermalized through collisions with a methane reagent gas at 10^{-3} torr. These low energy electrons (0-5 eV) are captured by the volatilized molecules forming radical anions. This energy alone is usually insufficient to break most chemical bonds. However, when combined with the thermal energy in the vaporized molecules additional fragmentation is possible.

Fragment ions may also form from the pyrolysis of molecules occurring during the heating of the sample on the solids probe (Scheme 5). Consequently, the resulting mass spectra may be dominated by fragment ions and not molecular ions. Thus, any empirical formulas obtained may not necessarily make sense from a valence standpoint and further analytical techniques may be needed to verify what is observed in resulting mass spectra^{118,120}.

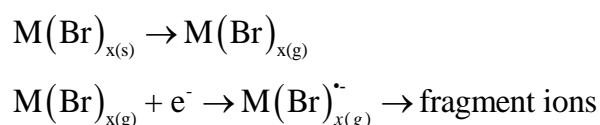

Scheme 5. Generation of ions of a brominated molecule, $\text{M}(\text{Br})_x$, using TD-NCI.

Mass Analyzers

The ions that are formed in the source are passed on to the mass analyzer. It is here where the ions are filtered using particular criteria to isolate a given mass range, a specific ion, or some combination if possible. Both trapping and transmission mass analyzers are discussed with regard to ion motion and some of the related electronics that allow for the filtering of ions.

Quadrupole Ion-Trap Mass Analyzer

Quadrupole ion-trap mass analyzer are among the more common MS instruments found in laboratories. Ion-traps are available in linear configurations, but the following is focused only on the 3-dimensional ion-trap. The ion-trap is based on the work of Wolfgang Paul and Hans Dehmelt, for which they were awarded the 1989 Nobel Prize in Physics¹²¹. These mass analyzers use electric fields to trap, store, or otherwise

manipulate ion in three dimensions. The storing of ions in a 3-dimensional trap is achieved through the application of radio frequencies and DC voltages to a central ring electrode and two end cap electrodes (Figure 7). To maintain the ions in the trap, the potential of the end plates is flipped before ions have the opportunity to collide with the electrode, thus creating a complex ion path in 3 dimensions as depicted in Figure 8 and modeled by Equation 1. Other ions follow similar trajectories concentric to the example based on the mass of the ion. Higher masses will be found outside of the given pathway while those of lower mass will be found closer to the center of the trap. The ejection of ions for detection is done by ramping the radio frequency (RF) field creating unstable ion trajectories which leads to the ions of a particular m/z value being accelerated toward the end cap electrode where they continue out through an opening and impact on the detector^{117,118,122}.

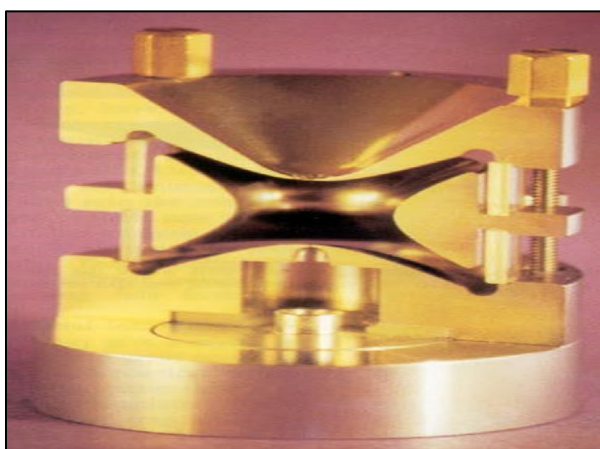

Figure 7. Example of an ion trap cut in half¹²².

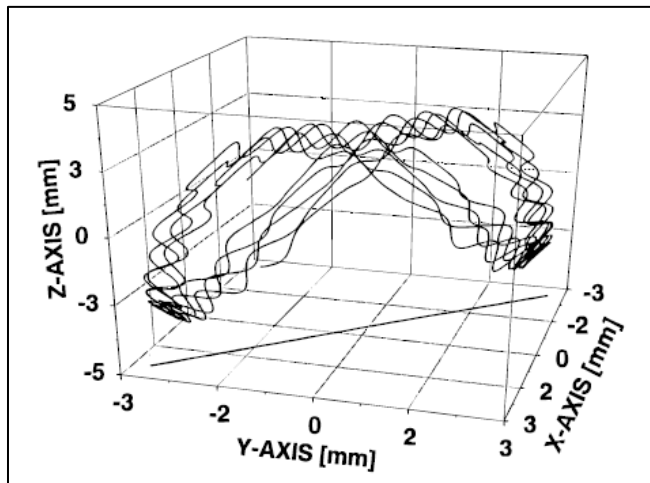

Figure 8. Modeled trajectory of an ion having a mass-to-charge ratio of 105 trapped in a 3-dimensional ion trap mass analyzer¹²².

$$\frac{d^2u}{d\xi^2} + (a - 2q \cos(2\xi))u = 0$$

Equation 1. Generalized equation for the path of an ion in the three dimensions where u represents the x , y , and z coordinates, a and q are dimensionless trapping parameters, Ω is the radial frequency of the applied potential, and $\xi = \Omega t / 2$.

The ion-trap mass analyzers perform mass spectrometric analysis over time. Ions are injected into the trap until a certain number of ions is present. Once the trap is filled, the RF is modulated leading to the ejection of the ions out of the trap and the subsequent detection of the ions in order of increasing mass. The trapping of ions takes up to 30 ms with the RF ramped taking 30-85 ms allowing for a single scan to be completed in around 120 ms. A complete mass spectrum is compiled by averaging a specified number of these microscans. In addition to scanning, a single desired ion of known m/z value could be trapped and the subsequently ejected for the detection of only that ion in an analysis known as selected ion monitoring, or SIM¹²².

Collision induced dissociation (CID) is a technique through which product ion spectra can be obtained. The ion-trap is controlled such as to trap a single ion of a known m/z value in the presence of a buffer gas such as nitrogen. The application of a resonant voltage gives the trapped ions a higher potential energy. The ions are then accelerated under the control of the higher potential energy causing the ions to collide with each other and the buffer gas. This soft ionization technique generates fragment ions from the desired molecular ion from low energy collisions with the reagent gas and the detection of the ions generates a product ion spectrum. The fragmentation of the stored molecular ion and sequential analysis of the ions generated from CID is referred to as tandem MS, MS/MS, or $(MS)^2$. The ion trap mass analyzer performs tandem-in-time mass spectrometry rather than tandem-in-space mass spectrometry, which will be discussed in the next section. In theory, it should be possible to continue trapping fragment ions leading to the generation of fragment ions of fragment ions, etc., or $(MS)^n$. However, practically speaking the continued trapping of fragment ions reduces the number of ions being present in the trap and thus a gradual decrease in signal intensity over time until such isolation and fragmentation of fragment ions is no longer possible. These types of experiments have found application in the structure elucidation of proteins and other high molecular weight compounds^{118,122}.

Triple Quadrupole Mass Analyzer

The triple quadrupole mass analyzer is an extension of single linear quadrupole mass analyzers. With the addition of a second mass analyzer, the triple quadrupole mass

analyzer is capable of experiments not previously possible. A single quadrupole is composed of four rods in a symmetrical arrangement allowing for the generation of hyperbolic electric fields (Figure 9). RF and DC sources are connected to the rods such that opposite rods have the same applied RF and DC potential. This configuration generates the electric field for the transmission and filtering of ions. To complete the configuration of a triple quadrupole MS, a second quadrupole mass filter is placed in series with the first mass analyzer. Between the two mass analyzers is an additional quadrupole that is operated in an RF only mode allowing all ions to pass through (Figure 10). CID may also occur in this RF only quadrupole¹¹⁸.

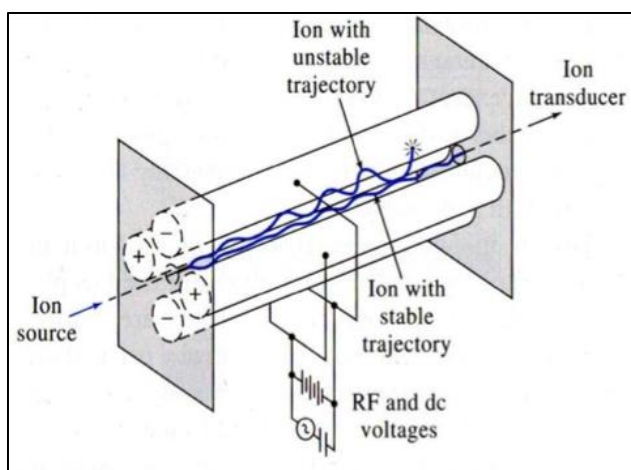

Figure 9. A single quadrupole mass analyzer¹²¹.

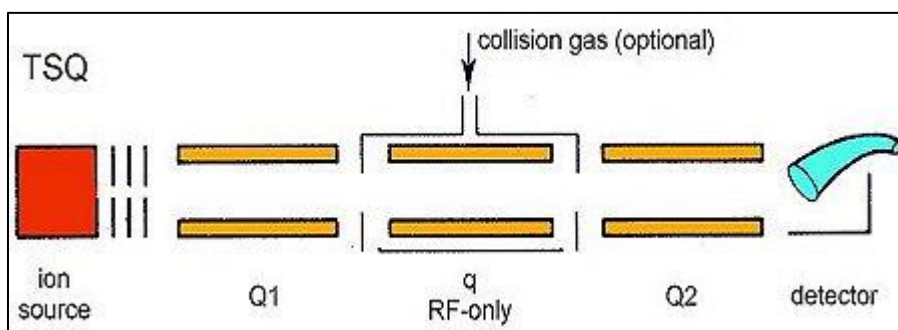

Figure 10. Configuration of a triple quadrupole mass spectrometer¹²³.

The generation of a mass spectrum is achieved by increasing or decreasing the RF frequency and DC potential at a fixed ratio. For any given combination of RF and DC, a specific m/z value will be allowed to pass through to the detector with other ions being filtered out (Figure 9). The complex ion motion in the mass filter can be described using for a bounded system where Φ is the potential distribution at time t , x and y are distances along the coordinate axis, r_0 is the distance from the z -axis to an electrode, ω is the angular frequency ($2\pi f$) of the applied AC signal, V is the magnitude of the applied RF signal and U is the magnitude of the DC potential applied to the surfaces (Equation 2). The more generalized description uses Equations 3 and 4. This unbounded situation has the ability to describe the trajectory of an ion that may collide with a surface and prevent its detection, thus being effectively filtered out. In these equations the a and q terms are related to the DC (U as previously defined) and RF (V as previously defined) respectively. The other variables are defined as follows: ze is the charge on the ion, r_0 is as defined previously, and m is the mass of the ion^{118,124}.

$$\Phi = [U + V \cos(\omega t)] \frac{x^2 - y^2}{2r_0^2}$$

Equation 2. Equation for the potential distribution at time t for a hyperbolic mass filter.

$$a_x = -a_y = 4zeU / m^2 r_0^2$$

Equation 3. Equation of motion for an ion having a given mass-to-charge ratio in the x - and y -axes as it relates to the applied DC.

$$q_x = -q_y = 2zeV / m^2 r_0^2$$

Equation 4. Equation of motion for an ion having a given mass-to-charge ratio in the x - and y -axes as it relates to the applied RF.

Time-of-Flight Mass Analyzer

The time-of-flight (TOF) mass analyzer measures the time required for an ion to travel from the source to the detector (Figure 11). The ions generated in the source receive a brief (about 10 ns) pulsed voltage (10^3 to 10^4 volts) that gives all the ions approximately the same kinetic energy. The ions then enter a drift tube in which no RF, DC, or magnetic fields are generated. In the drift tube, the ions separate out into clusters of ions having the same velocity allowing for the determination of their respective masses. Equations for kinetic energy (Equation 5) and the relation for the mass, charge and velocity of an ion (Equation 6) are combined to relate the time it takes the ion to be detected to its mass. Physics further informs that these ions of different masses, when accelerated with an equal potential and allowed to pass through an evacuated space of a given length, L , the ions will not all arrive at the same time. Thus the mass-to-charge ratio can be determined by combining all this information which leads to Equation 7^{117,118,121}.

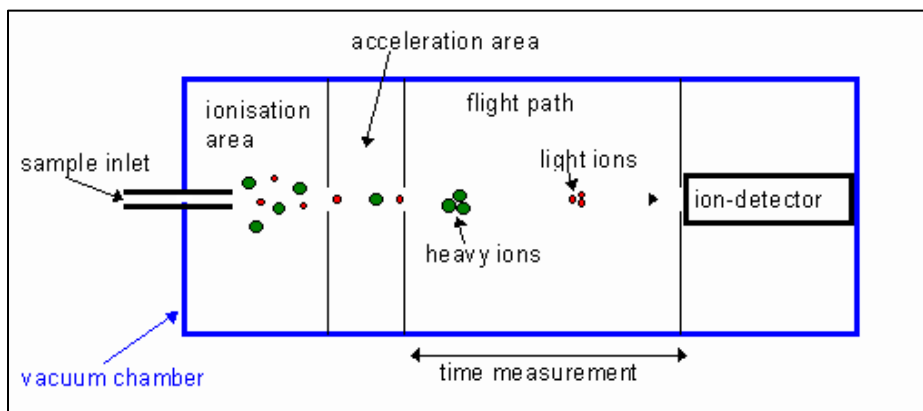

Figure 11. Diagram of the operation of a time-of-flight mass spectrometer¹²⁵.

$$E = zeV = \frac{1}{2}mv^2$$

Equation 5. Equation for kinetic energy.

$$v = \left(\frac{2zeV}{m} \right)^{\frac{1}{2}}$$

Equation 6. Equation relating an ion's mass-to-charge ratio in terms of the velocity of the ion.

$$t = \frac{L}{v} = L \left(\frac{2zeV}{m} \right)^{-\frac{1}{2}}$$

Equation 7. Equation relating the time until an ion is detected to the velocity given to an ion, the distance the ion travels and the mass and charge of the ion.

Orbitrap Mass Analyzer

Orbitrap mass analyzers are one of the more recent introductions into the market. These mass filters consist of two differentially shaped electrodes, one within the other. The outer electrode is barrel shaped and composed of two electrically isolated components, and the inner electrode is shaped like a spindle (Figure 12). Between these two electrodes is applied a constant electric potential. As the two electrodes are shaped the same, the electric field between the two electrodes varies based on the position along the z-axis. Ions are injected into the mass filter with a kinetic energy matching the potential energy of the electric field between the two electrodes and are trapped radially and oscillate around the z-axis. As a result of the design of the trap, the electric field experienced by the ions is not homogeneous. In the center of the trap, the electric field is at a minimum and increases uniformly in either direction as the ion moves away from the center. This causes the ions to oscillate around the z-axis. The frequency of these oscillations are mass dependent (Equation 8)

as a result of the non-parallel vectors of the electric field. Thus, the inhomogeneity of the electric field is utilized for the mass selection of ions. The electrically isolated components of the barrel shaped electrode sense a current as ions oscillate in them. The frequencies of these image currents are transformed into the resulting mass spectrum using a Fourier transform^{118,126}.

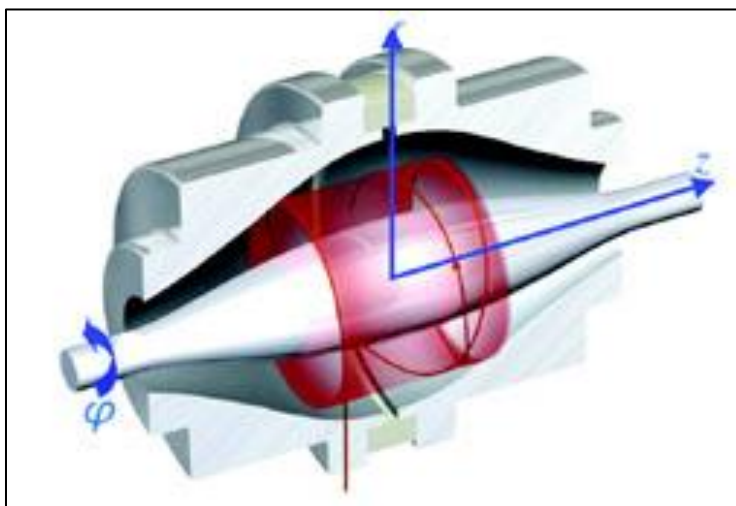

Figure 12. Cutaway of an orbitrap mass analyzer¹²⁷.

$$\dot{\omega} = \left[\left(\frac{z}{m} \right) k \right]^{\frac{1}{2}}$$

Equation 8. Equation relating the ion mass-to-charge ratio to the frequency of ion oscillation along the z-axis.

Fourier Transform Ion Cyclotron Resonance Mass Analyzer

Fourier transform ion cyclotron resonance mass spectrometry (FTICR-MS) was developed to improve signal-to-noise ratios, increase data collection speeds and improve sensitivity and resolution. FTICR-MS uses an ion trap that is designed to contain ions in well-defined orbits for extended periods of time. In a strong magnetic field, ion motion becomes circular in the plane perpendicular to the applied magnetic field

(defined as B). The frequency (referred to as cyclotron frequency or ω_c) of the ions in their respective circular orbits can be used to determine the mass-to-charge ratio and thus the mass of the ion (Equation 9). The scanning for ions of different masses necessitates scanning a radio frequency range. The applied energy can be absorbed by the ions if the frequency of the field matches that of the cyclotron frequency. This increases the velocity of the ion leading to an increase in the radius of rotation. Termination of the radio frequency allows the ion path to return to a constant state (Figure 13). The detection of ions is through the resulting image current. As the ions come into close proximity of the detector plates, the charge on the ions induces a movement of electrons in the plates, which is known as image current. The collection of these image currents as time-domain decay signals and converted to frequency-domain data using a Fourier transform. This frequency-domain data can be converted to a mass spectrum^{117,121}.

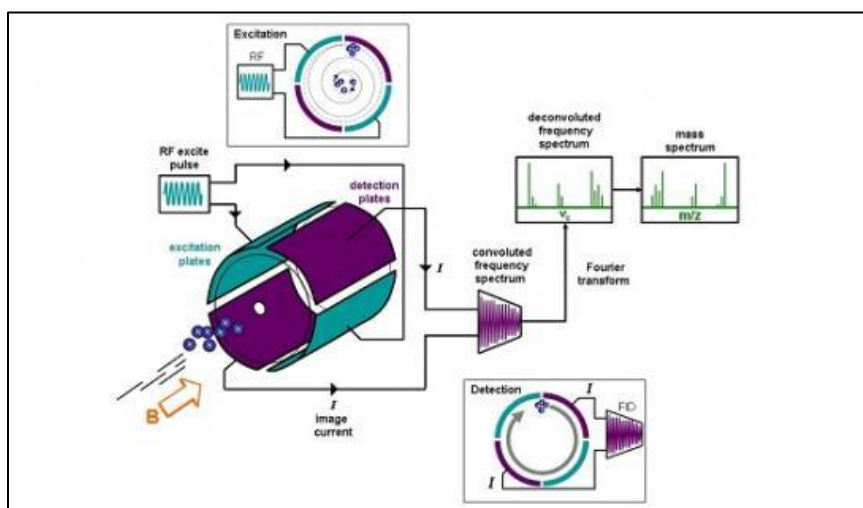

Figure 13. Schematic and operation of an FTICR-MS¹²⁸.

$$\omega_c = \frac{zeB}{2\pi m}$$

Equation 9. Equation for the cyclotron frequency as it relates to the magnetic field and the ion mass and charge.

Detectors

The final stage of mass spectrometry is the detector. As with other components of the mass spectrometer, the detector has undergone changes over the years leading to several different types of detectors being found on MS instrumentation. Detection of ions has been addressed for orbitrap and FTICR instrumentation as detection occurs within the component of the mass analyzer. Presented below are two of the more common detectors used in conjunction with the other mass analyzers.

Electron Multiplier

The electron multiplier uses the generation of secondary electron emission to amplify signal generation. The ions coming from the mass analyzer are focused onto a conversion dynode. Electrons are emitted from the conversion dynode in direct proportion to the number of ions that are bombarding it. In a discrete dynode multiplier (Figure 14), these secondary electrons are focused onto a second dynode that, upon impact with the electrons, generates more secondary electrons. Again, these secondary electrons are focused onto another and another dynode (often 10 to 20 dynodes in series) effectively proportionately increasing the signal that would have been generated from the initial ion impact¹¹⁸.

Continuous dynode versions of the electron multiplier operate under similar conditions. However, instead of distinct conversion dynodes, a continuous dynode is

constructed of glass doped with lead in the shape of a cornucopia. The surface of the dynode is electrically resistive which makes it possible to create an electrical gradient through its length when connected to a power supply. The dynode is positioned such as to capture a continuous beam of ions that impact the inner wall releasing secondary electrons. These secondary electrons then travel along the positive electrical gradient the length of the cornucopia while impacting the inner wall multiple times creating more secondary electrons that continue this cascade until detected at the narrow end of the dynode (Figure 14). As in the discrete dynode, secondary electrons generated from successive collisions leading to the generation of more secondary electrons and an amplification of the signal from the original ion¹¹⁸.

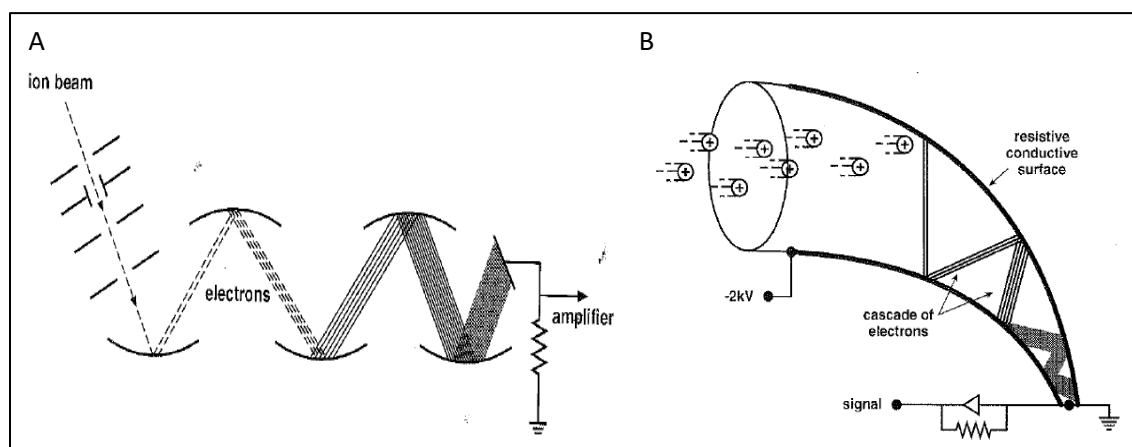

Figure 14. Diagrams of (A) a discrete dynode electron multiplier and (B) a continuous dynode electron multiplier¹¹⁸.

Multichannel Plate

The multichannel plate consists of many channels (up to several hundred per square inch) arranged as a honeycomb using metal doped glass (Figure 15). A potential difference is applied to opposite ends of the channels. This creates an electrical gradient

the length of the channels. Ions enter the channels off-axis causing them to impact the side wall ejecting electrons. These secondary electrons continue to impact the wall leading to additional secondary electrons being formed and an overall signal amplification of the original ion¹¹⁸.

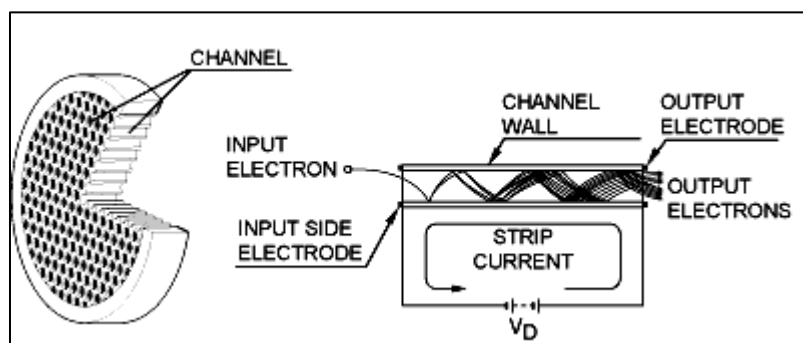

Figure 15. Schematic of a multichannel plate detector¹²⁹.

Comparison of Mass Spectrometry Instrumentation

The availability of different configurations for sources and mass analyzers, among others not discussed here, may make it difficult to determine which may be best suited for a given application. When considering instrumentation for mass spectral characterization, it is advantageous to determine what kind of resolution and resolving power is needed for the particular analysis. Resolution is simply defined as the separation of ions of two different m/z values (Δm). Resolving power (R) is defined as the difference in m/z values that can be separated from one another divided into a specific m/z value ($R = m / \Delta m$) and is a function of the mass spectrometer itself¹¹⁸. Cost and space requirements should be considered as well.

Ion-trap mass spectrometers have one of the lowest costs of ownership and are commonly found in academic institutions. In these instruments, all the generated ions

across a given mass range are available for spectral acquisition. However, the trapping of these ions may lead to space-charge-effects as well as a limited number of ions being available due to the size of the trap. Ion-traps are exceptional for full scan analysis though because of all the ions being available. Product ion analysis can be performed. Ion-trap mass spectrometers suffer though from poor resolving power, often being able to obtain resolution no better than 0.3 Dalton. The necessity of a buffer gas to be present in the trap may also generate some dissociation of molecules through collisions with the gas. Ion-traps also suffer from a poor dynamic range for quantification. Ion-traps are well suited for full scan spectral collection and occasional application for product ion analysis, but if accurate mass information or other types of mass spectral experiments are desired, other instruments are better suited to fill those needs¹¹⁸.

The triple quadrupole mass spectrometer is a special application of a single transmission quadrupole. These instruments are the next step up on the price scale and do occupy a larger footprint than an ion trap instrument. They are ideal for tandem MS related experiments (precursor ion scans, neutral loss, single/multiple reaction monitoring (SRM/MRM), and other tandem in space experiments). Resolution is constant throughout the mass range, though this does sacrifice resolving power at the low mass end. As with the ion trap mass spectrometers, resolution typically does not exceed 0.3 Dalton. Spectral acquisition rates are slow, around one spectrum per second, but can be increased by narrowing the mass range over which the spectrum is collected. These instruments are not well suited to full or product ion scans due to a reduction in

sensitivity as these are transmission instruments. Triple quadrupole mass spectrometers are exceptional for quantification, specifically when using SRM or selected ion monitoring (SIM) modes of operation, and have an excellent dynamic range for quantification¹¹⁸.

Time-of-flight mass spectrometers again increase in cost of ownership but offer some features necessary for characterization of unknown compounds. The discussion here will focus on reflectron TOF instrumentation rather than linear TOF mass spectrometers. TOF instruments are particularly well suited for different ionization sources beyond those discussed previously making them amenable to sample matrices otherwise not amenable to gas chromatography (GC) or liquid chromatography (LC) MS methods. TOF instruments are capable of quickly acquiring spectra and boast resolving powers necessary for mass measurements to within 0.1 mDa for ions less than 500 Da. The sensitivity is good as all the ions are detected. However, the need for a drift tube requires higher vacuums than other instruments, and TOF instruments are also more sensitive to changes in ambient temperatures which may change the length of the drift tube. TOF instruments suffer from a decrease in dynamic range from triple quad instruments, but still perform better than ion-trap instruments. In applications where full scan accurate mass data is needed, TOF instruments provide the most cost effective answer¹¹⁸.

Orbitrap mass spectrometers provide an increase in cost above that of triple quadrupole instruments. These instruments are smaller in comparison to TOFs and

triple quads. They commonly boast resolving powers above 70,000 and are comparable to FTICR instruments and at a lower cost. Mass accuracy of 2-5 parts per million (ppm) allow for accurate mass determination and molecular formula generation similar to TOF instruments. These instruments have a higher trapping capacity than 3D ion traps and FTICR instrumentation thus increasing their sensitivity in full scan analysis. Orbitrap instruments have the ability to perform CID and some tandem MS experiments (tandem in time experiments) such as product ion scans. Scans can be performed quickly and in less time than other trapping instruments. However, orbitrap instruments suffer from inefficient trapping of ions resulting in a potential decrease in sensitivity. These instruments also require low pressures to properly operate leading to an increase in energy consumption and costs for necessary pumps. Orbitraps also have a wide linear dynamic range. These instruments are exceptional for accurate mass determinations, but TOF instruments may perform as well, though at a possible sacrifice in resolving power, and at a lower cost¹¹⁸.

FTICR mass spectrometers are sit at the top end of the cost scale and are relatively complex to operate. FTICR instrumentation boasts exceptional resolution and mass accuracies of 0.1 to 2 ppm making these instruments ideal for molecular formula generation and unknown identification. Scans are performed quickly and in a fraction of the tie needed for other trap based instruments. These instruments need to be operated at lower pressures and use superconducting magnets thus necessitating proper maintenance leading to an increase in ownership costs. Mass accuracy and

speed of data collection may be advantageous, but alternatives exist at a lower cost though with a sacrifice in mass accuracy and resolving power¹¹⁸.

Mass Spectrometry Based Methods

The use of ion-trap mass spectrometry, while not widely used for the analysis of emerging contaminants, has seen some use. Typical applications involve the development of methods from standards followed by sample extraction and analysis with comparison of spectral data to that of the standards. This targeted methodology is among the more common routes that are used to study emerging contaminants. Analytes of interest may be chosen from the Environmental Protection Agency's (EPA) list of emerging contaminants allowing the researcher to develop and optimize methods specifically for what was chosen¹³⁰. Analysis of environmental sources for these compounds may be directed using information related to manufacturing, such as quantities produced and sold²³.

Cocaine and two of its metabolites have been analyzed in surface and wastewaters in such a targeted manner using ion trap tandem mass spectrometry. An LC-MSD (mass selective detector) ion trap with electrospray ionization was used for detection by monitoring two characteristic ions per compound in a manner similar to single reaction monitoring (SRM). Surface waters from Belgium, Italy, Spain, and Switzerland were found to have concentrations of up to 26 ng/L cocaine and 191 ng/L benzoylecgonine. In waste waters concentrations up 678 ng/L and 1898 ng/L of cocaine and benzoylecgonine, respectively, were observed. The second cocaine metabolite,

ecgonine methyl ester, was not reliably quantified¹³¹. Ion-trap mass spectrometers coupled to LC have also been used to analyze aqueous matrices for haloacetic acids¹³², suites of pesticides and other selected organic pollutants taken from the European Union Directive EC 76/464¹³³, a compilation of approximately 90 polar organic environmental pollutants across several compounds classes taken from a number of agencies across Europe and the United States¹³⁴, and selected pharmaceuticals from different compound classes⁸⁵.

The targeted analysis of emerging contaminants has also been performed using the triple quadrupole mass spectrometer^{135,136}. As the analytes have been previously identified and characterized (product ion spectra is known), it is possible to use SRM as a sensitive and specific tool to detect a specific compound in a complex matrix. SRM can also be used for the quantification of the target analyte, most often using isotope dilution mass spectrometry¹³⁷. In isotope dilution mass spectrometry, a stable isotope labeled standard is spiked into the sample at a known mass or concentration prior to extraction. This internal standard is often the same as the analyte of interest except it is isotopically enriched, often using deuterium or carbon-13. This shifts the measured mass higher allowing it to be easily distinguished from the mass of the analyte. The concentration of the unknown sample can easily be calculated from the ratio of the peak areas of the analyte of interest and the stable isotope internal standard¹¹⁷. Other options such as constant neutral loss (CNL) analysis and precursor ion scanning present options for targeting molecules with a specific substructure. Phase II metabolites

containing a glucuronic acid moiety can be screened for using CNL as these compounds commonly fragment with a neutral loss of 176 Da (anhydroglucuronic acid) in either positive or negative modes of detection^{138,139}. Other possible neutral losses include HX (where X is some halogen), HCN (from nitriles), and NO and NO₂ (from nitro aromatics) as examples¹⁴⁰. Precursor ion scanning can be used to find compounds in which a specific fragment ion arises, such as characteristic losses of Cl⁻, Br⁻, and I⁻, leading to the molecular weight of the unknown. As the only logical formation of a fragment of m/z 35 or 37 is from chloride, precursor ion scanning is an extremely sensitive tool for the detection of compounds containing chlorine. These experiments are depicted in Figure 16.

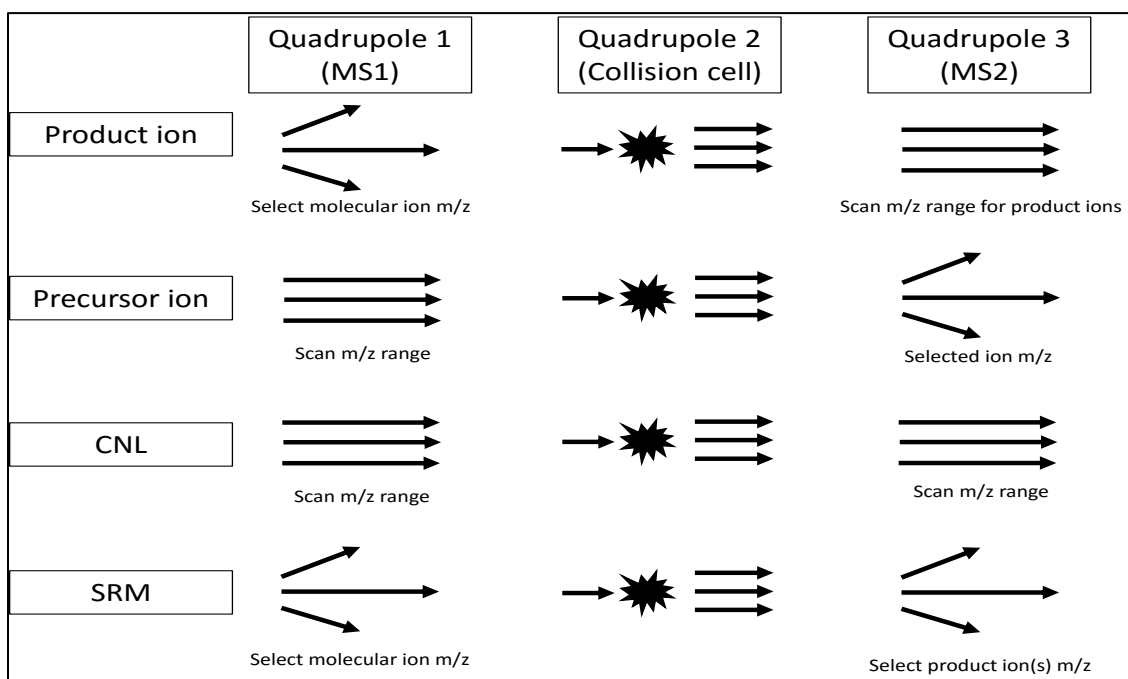

Figure 16. Schematic diagrams of MS/MS experiments.

The versatility of the triple quadrupole mass spectrometer makes it very useful for both identification and quantification of emerging contaminants. As a consequence of lower resolution, triple quadrupole instruments are more commonly used for targeted analysis and quantification. Selected reaction monitoring can be used as a sensitive technique for the detection of emerging contaminants in a targeted manner. Stolker et al.¹³⁵ utilized liquid chromatography triple quadrupole mass spectrometry in the analysis of surface, drinking, and ground waters for the presence of four analgesics, three antibiotics, five blood-lipid regulators and beta-blockers, and an anti-epileptic first by screening for a single fragment ion and then performing a confirmatory analysis of the sample by detecting two fragment ions coming from the molecular ion (an SRM method for both analysis). Other environmental contaminants that have been detected, often using SRM, include haloacetic acids in tap water¹³⁶, selected neutral pharmaceuticals from several medicinal groups in ground, river and waste waters¹⁴¹, and illicit drugs and their related metabolites in wastewater for examples²¹. SRM analysis has also been applied using isotope dilution mass spectrometry for quantifying BPA in human tissue and urine samples¹³⁷. Ding and Zhang¹⁴² used precursor ion scans for the detection of iodinated DBPs in drinking water. While the identity of the observed DBPs were not conclusively made, this work demonstrates that triple quadrupole instruments can effectively screen for particular functional groups leading toward a workflow more directed at compounds which have some degree of implied toxicity coming from particular structural features.

Non-targeted approaches may also be employed in the identification of emerging contaminants. Such methodologies employ full scan techniques that provide accurate mass data (m/z values measured to at least seven significant figures) and are more commonly the detection of “known unknowns” rather than a truly non-targeted approach in which nothing about the sample or desired target is known¹⁴³. From this data, empirical formulas can be suggested allowing for databases (such as SciFinder Scholar, ChemSpider, and PubChem) to be searched to determine the identity of the unknown^{144,145}. Researchers may also create their own databases containing compounds of environmental relevance for a particular compound class that will contain retention times and fragmentation data to help differentiate isomers¹⁴⁶. The success of a “known unknown” approach is predicated on the fact that the structures of the emerging contaminants can be found in databases.

Accurate mass analysis, particularly via time-of-flight (TOF) MS, has seen widespread usage in the non-targeted analysis of emerging contaminants because of the instruments high mass resolution and fast scanning speeds leading to well resolved chromatograms¹⁴⁶⁻¹⁴⁸. While an accurate mass can lead to a proposed formula, the higher the determined mass, the more possible formula there exist to match. Using the online tool ChemCalc, at m/z 250, more than 500 molecular formula will fit within a 5 ppm (parts per million) window when considering all possible combinations of C, H, N, O, S, P, Si, and all halogens. When considering a larger mass, say m/z 400, more than 900 molecular formula exist within a 0.3 ppm window¹⁴⁹. The large pool of possible

formula can be further simplified when considering standard rules of bonding. Searches using the ChemSpider database to facilitate searches based on standard rules of bonding, about 120 molecular formula with structures, including all isomers, are possible with a 5 ppm mass error. For m/z 400, just over 350 formulas and structures, including all isomers, are possible within a 5 ppm mass error¹⁵⁰. These searches, however, did utilize limiters for elemental composition as done using ChemCalc. If spectra present sufficiently strong signals, isotopic abundances can be used to further guide the formula search and reduce the number of possibilities¹⁵¹. Identification of the compounds can further be facilitated with product ion spectra that can give an indication of functional groups specific to the molecule¹⁴³.

Ibáñez et al.¹⁵² developed a methodology using liquid chromatography coupled to a hybrid quadrupole time of flight mass spectrometer for the identification of unknown emerging contaminants. Full scan and product ion spectra were collected from ground and surface waters samples from Spain. The masses observed in the full scan spectra were utilized to generate formula, taking into account isotopic abundances, which were then searched for in databases. Structures that were found were evaluated based on the fragmentation patterns observed in the collected product ion spectra. With this approach, three contaminants were identified as the fungicide enilconazole, the herbicide terbutryn, and the herbicide diuron. A similar approach was applied in an analysis of surface waters leading to the identification of carbamazepine and triphenylphosphine oxide as well as a tentative identification for N,N-

dicyclohexylmethylamine¹⁴⁸. In a study characterizing sewage plant effluents, TOF instrumentation was used to tentatively identify 20 environmental contaminants including pharmaceuticals, flame retardants, pesticides, herbicides, food and beverage additives, and natural products¹⁵³.

Gas chromatography coupled with TOF-MS has also been applied in the analysis of emerging contaminants. Matamoros et al.¹⁵⁴ used 2D-GC-TOF-MS for the simultaneous determination of 97 organic contaminants (including pesticides, pharmaceuticals, personal care products, herbicides, biocides, and PAHs) in river waters from Spain. Both targeted and non-targeted identification of emerging contaminants is possible. Given the accurate mass data, unidentified peaks in a targeted analysis can be searched and further analyzed toward finding an identification. Hernández et al.¹⁵⁵ developed a method for targeted analysis was developed on a suite of 60 organic pollutants. Analysis of the data led to the identification of diazinon, galaxolide, bisphenol A, and others that were not originally included in the list of 60 targeted analytes. Non-targeted identification of emerging contaminants has also been demonstrated on landfill leachate leading to the tentative identification of 44 compounds with another 36 components have elemental compositions determined. Among the identified compounds were caffeine, hexathiepane, and caprolactam (a precursor to Nylon 6)¹⁵⁶.

The advantage of utilizing GC as opposed to LC is the variability of the source and the possibility of using both hard ionization (electron impact) and soft ionization (such

as chemical ionization) techniques. Hard ionization would provide product ion spectra data that would be more extensive than that obtained using ESI and CID. The soft ionization techniques would allow for the determination of the molecular ion in much the same manner as ESI as found on LC instrumentation. Portolés et al.¹⁵⁷ used four model compounds (bifenazate, boscalid, epoxiconazole, and fenhexamid) to demonstrate the feasibility and practicality of this type of combined approach in using information from spectra resulting from both soft and hard ionization.

High resolution mass analyzers such as orbitraps and FTICRs have also be used to identify emerging contaminants, but are seen with less frequency compared to triple quadrupole and TOF instruments. Methods have been developed for the determination of pharmaceuticals in water using orbitrap mass spectrometers following LC separation of the analytes. Pinhancos et al.¹⁵⁸ developed a method using a hybrid orbitrap mass spectrometer for the analysis of nine pharmaceutical compounds and then proceeded to test tap and bottled water for these nine compounds. Among those compounds detected, erythromycin and fluoxetine were found in both tap and bottled water. Wastewater samples have been utilized for the development of a method, also using a hybrid orbitrap mass spectrometer, for the detection of nitrosamines in wastewater. N-Nitrosodimethylamine (NDMA) and N-nitrosomorpholine (NMOR) were among the more frequently occurring compounds of the nine targeted nitrosamines. NDMA ranged in concentration from 1.6 to 22 ng/L and NMOR was present in concentrations of 2.7 to 14 ng/L both in effluent¹⁵⁹.

FTICR-MS has been used to identify 473 bromine containing DBPs in artificial drinking water containing high levels of bromide and treated using chlorination. In a comparison of these compounds to what was readily available in the literature, no matches were found though differences in instrumentation (GC vs. LC) is likely why. It was hypothesized that a number of these compounds were rich in carboxyl groups, which would be well suited to analysis using LC-ESI-MS/MS. The masses of the identified compounds were within the range of 200 to 500 Daltons (Da)⁵⁹.

High resolution mass spectrometry, such as FTICR-MS and orbitrap MS, have been applied to more complex matrices such as oil sands process water. These two instruments were used in the determination of compounds present in oil sands process water. The majority of the compounds that were detected were $C_{15-20}SO_3$ species and $C_{27-28}SO_5$ species. Fragments created through CID from these compounds were due to water, methanol, methyl formate, and/or combinations of these compounds. While the exact mass data allowed for the generation of molecular formula, the ambiguity of the fragment ions generated through CID lead to only partial structure identification. It is hypothesized that the oil sands process water contains compounds that are alicyclic, aromatic hydroxyl carboxylic acids, or sulphones¹⁶⁰.

The variety instrumentation simply in the realm of mass spectrometry presents many options for the analysis of environmental emerging contaminants. Analysis of samples across MS platforms will provide complimentary data, and the combination of screening methods on low resolution instrumentation with the accurate mass abilities of

high resolution instrumentation can lead to more rapid identification of unknowns facilitating future research on the identified emerging contaminants.

Other Instrumental Methods

Mass spectrometry may be the preferred method for the detection and determination of emerging environmental pollutants, but other methods have been applied to the field. Discussed below are several examples of other analytical techniques that have been utilized, commonly in a targeted manner, with varying degrees of success.

Ion Chromatography

Ion chromatography (IC) with conductivity detection can be used for the targeted analysis of HAAs. Baseline separation of the common HAAs is achievable. However, there can be some overlap in signal with inorganic anions, such as sulfate, nitrate, nitrite, and chloride. A major drawback to IC methods for the analysis of HAAs is the higher limit of detection (LOD) when compared to methods based on mass spectrometry. LODs for IC based methods for HAAs range from about 0.09 µg/L to over 300 µg/L depending on sample pretreatment and extraction methods. Standardized methods for HAA analysis based on gas chromatography mass spectrometry (GC/MS) have limits of detection at least an order of magnitude lower than the low end reported by IC methods (LOD of 0.0074 -0.085 µg/L via GC/MS)^{161,162}.

Electrochemical Techniques

Electrochemical detection of selected emerging contaminants using square-wave voltammetry and adsorptive cathodic stripping voltammetry has been demonstrated for the selective analysis of diclofenac, tartrazine, dexamethasone, and alprazolam. Surface water and wastewater were analyzed with and without prior pre-treatment or extraction for the specified compounds yielding LODs in the range of 0.4 µg/L to approximately 80 µg/L. While limits of detection do not necessarily compare favorably to MS based methods, the significantly lower cost of instrumentation and personal training may make electrochemical methods an economical route for targeted analysis. The targeted analyte, though, must be electrochemically active and detected over the large background of naturally occurring components that may also generate a response from the selected electroanalytical technique^{163,164}.

Diode Array and Fluorescence Detectors

Diode array and fluorescence detectors have been employed for the targeted detection of emerging contaminants as well^{165,166}. Montagner and Jardim¹⁵⁹ employed both detectors in developing a method to detect a suite of 15 emerging contaminants in surface water. Samples were extracted and then separated using high pressure liquid chromatography (HPLC). LODs ranged from 38 ng/L for caffeine up to 170 ng/L for ibuprofen. With these detectors, though, good chromatographic resolution is necessary to allow for reliable quantification. A good understanding of the matrix is important to ensure that the matrix is not interfering with the signal of the analyte. For targeted

analysis, these detectors do present themselves as more affordable alternatives to MS based methodologies.

Nuclear Magnetic Resonance Spectroscopy

True unknown identification can be supplemented very well through the utilization of nuclear magnetic resonance (NMR) spectroscopy. Through the coupling of LC, NMR, and MS, structural information obtained through MS and NMR can be correlated using retention times. However, NMR lacks the necessary sensitivity for it to be used to aid in the identification of all unknowns unless appropriate sample concentration and purification steps are performed. LC-NMR can be performed with continuous flow LC or through stop-flow techniques^{167,168}.

One of the most difficult problems in water monitoring is the identification of the components of NOM. Simpson et al.¹⁶⁹ demonstrated the use of NMR toward the identification of NOM components. In their work, LC-NMR was carried out under stop-flow conditions. Small portions of the LC eluate were trapped in individual sample loops based on a signal response from an online diode array detector before loading into the NMR. Solid phase extraction (SPE) cartridges were also utilized as a trapping medium for small volume fractions of the LC eluate. Trapping of the eluate onto an SPE cartridge, which can be done on- or off- line, allows for the utilization of deuterated solvents in NMR and also improves the signal to noise ratio when compared to trapping in a sample loop or continuous flow LC-NMR methods. The complexity of the proton NMR spectra could not lead to the identification of any NOM components. It was proposed that using

2-dimensional and heteronuclear NMR analysis techniques would lead to the elucidation of NOM components when coupled with MS methodologies.

Van Leerdam et al.¹⁷⁰ used high resolution MS (HRMS) data combined with 2D and heteronuclear NMR techniques leading to the identification of the previously unknown 4,4'-dihydroxy-3,5,3',5'-tetra (hydroxymethyl) diphenylmethane in the Meuse River in The Netherlands. The HRMS data allowed for the determination of the elemental composition to within 5 ppm mass error and the heteroatoms Cl, Br, Si, and S were eliminated based on the absence of necessary isotope patterns. Product ions from tandem MS experiments also facilitated in the determination of the elemental composition. However, with over 100 possible compounds found in databases, identification of the unknown beyond a proposed formula was impossible leading to the utilization of NMR. Proton and ¹³C NMR spectra in addition to HMBC and HSQC spectra allowed for the correlation of carbons and protons giving an indication of connectivity leading to the final identification of the microcontaminant as 4,4'-dihydroxy-3,5,3',5'-tetra (hydroxymethyl) diphenylmethane, which is found as an intermediate in the cure process of cresol phenol-formaldehyde resins. It is hypothesized that this compound is coming from resin production plants located upstream from the sampling location¹⁶⁴.

Study Objectives

Non-targeted analysis of emerging contaminants commonly utilizes high resolution mass spectrometry which may not be easily accessible by researchers.

Instrumentation capable of tandem MS experiments such as triple quadrupole mass

spectrometers, by comparison, are typically more affordable and accessible. Tandem MS instrumentation boasts excellent quantification capabilities through the utilization of SRM methods allowing for detection and quantification of trace level known contaminants.

Full scan tandem MS methods are utilized for the screening of unknown, potentially harmful emerging contaminants. Full scan tandem MS methods may be used to detect specific functional groups based on the formation of characteristic ion masses, such as m/z 35 and 37 for chlorine or m/z 79 and m/z 81 for bromine. Searching for specific isotope patterns combined with accurate mass analysis is used to determine the identities of chlorinated and brominated DBPs formed from a brominating disinfection reagent and in natural water as well. Precursor ion and constant neutral loss analysis can easily be utilized to detect these fragments. Tandem MS instrumentation can perform product ion scans as well. The data generated contributes necessary structural information for positive identification. However, empirical formula cannot be deduced from these instruments as a result of the low mass resolving power making high resolution mass spectrometry a necessary supplemental tool toward the identification of unknown emerging contaminants.

Considering the versatility of tandem mass spectrometry, screening methods for a variety of water samples for the presence of particular structural features are developed. Chromatographic peak heights guide which peaks to further investigate and attempt to identify. Those with the highest peak intensities are first investigated

assuming that the compounds resulting for these peaks are present at the highest concentrations in the sample. Utilizing high resolution MS data for these peaks, formulas can be proposed and databases can be searched for possible matches. Additionally, product ion spectra are collected. Proposed compound matches for the investigated masses can be purchased or otherwise synthesized and the mass spectral data and retention time can be matched to determine if the correct identity of the unknown has been assigned. Proper identification of the initial peak of interest will match the product ion spectrum as well as retention time and have a mass accuracy within 5 ppm.

CHAPTER THREE

THE EXPERIMENTAL DESIGN

Reagents

Triclosan and 2,6-dichlorophenol from Sigma-Aldrich (St. Louis, MO, USA) were used without further purification to prepare working solutions (1 mg/mL) used for the optimization of conditions for liquid chromatography and mass spectrometry. The chromatography for gas chromatography electron capture detection (GC-ECD) was optimized with a standard trihalomethanes mix (AccuStandard, Inc., New Haven, CT) containing chloroform, bromoform, dibromochloromethane, and dichlorobromomethane, which was diluted by a factor of 10 using pentane (Sigma-Aldrich).

Methanol, hydrochloric acid, formic acid, and ammonium hydroxide were acquired from VWR (Chicago, IL, USA). Acetonitrile, 2,3-dichlorophenol, 2,4-dichlorophenol, 2,5-dichlorophenol, 3,4-dichlorophenol, and 3,5-dichlorophenol were acquired from Sigma-Aldrich (St. Louis, MO, USA).

Ultra-pure water was obtained from a Barnstead Nanopure system (Thermo Scientific, Waltham, MA, USA).

Water Sampling

Hot tub samples (pH approximately 7.4) were obtained from the hot tub located in the Norville Center for Intercollegiate Athletics at Loyola University's Rogers Park

Campus during the 2014-2015 academic year. Approximately three liters were obtained as a grab sample. A grab sample is water taken from a location at one particular time, usually from the top 1-2 feet of water. These samples were used to investigate for the presence of brominated disinfection by-products.

All water samples were filtered twice through Whatman GF/A glass microfiber filters (1.6 μm pore size) or comparable filters (VWR, Chicago, IL, USA).

Sample Extraction

Water samples for brominated DBPs were extracted initially using liquid-liquid extraction (LLE) as a “broad-brush” extraction technique before transitioning to SPE. Two LLE methods were modified from EPA methods 552.2¹⁷¹ and 501.2¹⁷² which are methods designed for the analysis of haloacetic acids and halomethanes.

The first LLE method used one hundred milliliters of water that was acidified to a pH of less than 2 using concentrated sulfuric acid (VWR, Chicago, IL). Fifty milliliters of this sample was combined with 10 mL of methyl tert-butyl ether (VWR, Chicago, IL) in a separatory funnel. The solution was thoroughly mixed and allowed to separate into layers, and the aqueous layer was removed. Another 50 mL of the acidified sample was combined with the remaining organic layer and mixed. The organic layer was removed, placed into a vial and evaporated to dryness using a steady nitrogen gas stream. The resulting residue was dissolved in 300 μL of methanol and 10 μL of concentrated ammonium hydroxide to convert the acids to salts and then analyzed.

The second LLE method used 200 mL of water and 3 mL of pentane as the extraction solvent. The water and pentane were combined in a separatory funnel and

thoroughly mixed. The pentane layer was removed and placed in a vial to which had previously been added a small amount of anhydrous sodium sulfate (to remove any residual water from the pentane layer). Approximately 300 μL of pentane was transferred to a vial for analysis.

Solid phase extraction was performed using Waters Oasis HLB SPE cartridges. Cartridges were conditioned using methanol and water each containing 0.25% formic acid. Five hundred milliliters of water, acidified to contain 0.25% formic acid, were passed through the SPE cartridge. The cartridges were dried briefly by air aspiration after loading the sample followed by elution using methanol containing 0.25% formic acid. The eluate is evaporated to dryness, and the resulting residue is dissolved in 300 μL of a methanol solution for analysis⁴⁸.

Studies were carried out to investigate if 1-Bromo-3-chloro-5,5-dimethylhydantoin (BCDMH) may undergo hydrolysis, decomposition, or reactions between degradation products of only BCDMH. Approximately 150 mg of BCDMH (PROTech Brominating Tablets as 96% BCDMH by weight) was dissolved in 800 mL of water (ultra-pure or 18 M Ω water, tap water, and water from Lake Michigan) while heating continuously at 45°C. The concentrations of BCDMH used in this experiment were consistent with that of hot tubs. One hundred milliliter samples were taken and extracted as described above using liquid-liquid extraction before the addition of BCDMH, after 24 hours, 48 hours, and after 7 days of stirring.

Reaction Design for the Oxidation Products of Triclosan

The design of these studies was constructed such as to chemically oxidize triclosan to determine potential oxidation products that may form in the environment. The reaction mixture contained 12.5 mL of 12% hydrogen peroxide and 500 μ L of a triclosan solution (52 mg/mL). Samples were then adjusted to selected pH values (3-10) in approximately one pH unit increments using 1 M sodium hydroxide. The samples were allowed to react for at least 48 hours. The reactions were then quenched using a stoichiometric excess of sodium sulfite¹⁷³ and neutralized using acetic acid. The solutions were analyzed without further workup.

Sample Analysis

Hot tub samples which were extracted using LLE were analyzed using GC-ECD. A Shimadzu (Tokyo, Japan) GC-2010 Plus with an ECD detector was used with a Restek (Bellfonte, PA) RTx-5MS column (60 m, 0.25 mm inner diameter). The injector temperature was 50°C, and one microliter of sample was injected. The column oven was held at 35°C for two minutes and then ramped at 5°C per minute to 180°C followed by a one minute hold. The temperature was again increased at a rate of 20°C to a final temperature of 270°C and held for one minute. Total run time was 30 minutes. Methane was used as the make-up gas at a flow of 30 mL/min. The carrier gas was helium at a flow of 1.5 mL/min.

Selected samples of hot tub water and related reactions (analyzed for product ion spectra) and neat samples of the triclosan oxidation studies were analyzed on an Agilent 6460 Triple Quadrupole Tandem Mass Spectrometer interfaced to an Agilent

Infinity 1290 LC system. Sample injections were 20 μ L, and chromatography was performed at a flow rate of 0.2 mL/min using an XTerra C18 column (100 x 2.1 mm, 5 micron) with an XTerra C18 guard column (10 x 2.1 mm, 5 micron) (Waters Corp., Milford, MA, USA). Ions were detected in negative ion mode for all experiments.

Most chromatographic separations were carried out using gradient elution with water (solvent A) and methanol (solvent B) each containing 0.25% formic acid. The initial condition of 2% B was held for 3 minutes followed by a linear increase to 40% B over the next 10 minutes. A linear increase to 98% B was then applied over the next 8 minutes followed by a hold for 8 minutes. Initial conditions were reestablished and the column was equilibrated over 8 minutes for a total run time of 38 minutes.

LC/TOF-MS analyses were carried out with a Waters 2620 HPLC interfaced to a Waters Synapt Q-TOF operated in V-mode at the University of Illinois-Chicago's Research Resource Center (RRC). Chromatography was performed similarly to that as described above. Briefly, 10% B was increased to 40% B over 10 minutes followed by an increase to 90% over 10 additional minutes. Conditions were held at 90% B for 8 minutes before returning to starting conditions and equilibrating for 5 minutes. Total run time was 36 minutes. Injection volumes ranged from 15-40 μ L for LC/TOF-MS analysis depending upon the concentration of the sample.

Samples for the analysis of brominated DBPs were analyzed using full scan accurate mass analysis using a thermal desorption probe coupled with negative chemical ionization (TD-NCI) TOF-MS. Fifteen microliters of the reconstituted extract was deposited in a capillary vial and placed in a thermal desorption probe directly

coupled to the source of an Agilent 7200 GC Q-TOF by a silica transfer line at the NIH/NIGMS Biomedical Mass Spectrometry Resource at Washington University in St. Louis, MO. Radical anions were generated by NCI using methane as the buffer gas. The probe and transfer line temperature was held at 40°C for two minutes. The temperature was ramped up at 20°C per minute to 300°C and held for two minutes. The total run time was 18 minutes. Mass spectra were inspected for ions separated the ^{81}Br - ^{79}Br mass difference to identify brominated ions¹⁷⁴.

A ThermoFinnigan LCQ Advantage Mass Spectrometer System was used to screen for triclosan oxidation products in only those reaction mixtures adjusted to a pH of approximately 10. A continuous flow (50 $\mu\text{L}/\text{min.}$) of sample was injected into the MS. Data were acquired for 4 minutes per mass range by scanning over three individual mass ranges, 50-120 Daltons, 135-185 Daltons, and 280-315 Daltons, based on the masses of known triclosan degradation products and metabolites. The mass spectra were interrogated for the characteristic isotope pattern of chlorine or for other masses known to be potential degradation products of triclosan. This demonstrated that the reaction design led to the formation of triclosan oxidation products. Further confirmatory analysis was conducted using high resolution mass spectrometry as previously mentioned.

Subsequent samples of reactions across the pH 3-10 range were analyzed using the Agilent triple quadrupole mass spectrometer interfaced to the Agilent 1290 HPLC. A water/methanol gradient was used to carry out the separation. Gradient conditions were different from those discussed above and are summarized in Table 1. All six

dichlorophenol isomers were analyzed by LC/MS and LC/MS/MS methods in order to identify the dichlorophenol products produced during the triclosan oxidation/degradation. Product ion analysis was performed on six dichlorophenol standards. The standards and samples from the bench top reactions were also analyzed using SRM and SIM. SIM analysis was more commonly used due to the increased sensitivity and the relatively simple matrix. Instrumental conditions for the mass spectrometer are summarized in Table 2.

Table 1. Summary of chromatographic conditions for the analysis of triclosan oxidation products.

Time (min.)	% Solvent B
0	2
2	2
4	50
16	50
29	98
34	98
35	2
40	2

Table 2. Mass spectrometric conditions for triclosan oxidation product analyses.

Instrument Parameter	SRM Method	Product Ion Method	SIM Method
Fragmentor voltage (V)	135	135	135
Collision energy (eV)	NA	20	25
Sheath gas temperature (°C)	300	300	300
Nebulizer (psi)	45	45	45
Capillary voltage (V)	-1500	-1500	-1500
Sheath gas flow (L/min)	8	8	8
Dwell time (ms)	200	500	200
Column Temperature (°C)	22	22	22

Empirical Formula Determinations

Monoisotopic masses, and in some instances nominal masses, were used to generate formula using the ChemCalc¹⁴⁹ website. Limiters for atom selection are user specified. Initial searches were limited to just carbon, hydrogen, oxygen, and nitrogen unless mass spectral data indicated the presence of other atoms through characteristic isotope ratios, such as bromine. Phosphorous, fluorine, and sulfur were also considered with subsequent searches if the initial search criteria did not result in any logical formulas being proposed. Empirical formulas were filtered based on mass accuracy.

Suggested empirical formulas were then filtered for standard rules of bonding. The resulting formulae were searched for in databases to find possible matching compounds. SciFinder and ChemSpider were the primary databases used in the searches. Those formulae with matching compounds were put forward as possible identities for the molecular ions under investigation.

CHAPTER FOUR

WATER DISINFECTION BY-PRODUCTS FORMED FROM 3-BROMO-1-CHLORO-5,5-DIMETHYLHYDANTOIN (BCDMH)

Introduction

The disinfection of swimming pools is normally carried out using gaseous chlorine, sodium hypochlorite, or other stabilized forms of chlorine (trichloroisocyanuric acid, sodium dichloroisocyanurate)¹⁷⁵. The reaction of these compounds with water leads to the formation of hypochlorous acid. The disinfection of the water is a result of the diffusion of hypochlorous acid through the bacterial cell membrane resulting in disruption of cellular metabolism. Brominating disinfectants used in hot tubs, such as 3-bromo-1-chloro-5,5-dimethylhydantoin (BCDMH) (Figure 17), undergo a similar reaction to form hypobromous acid as the ultimate disinfectant (Scheme 6). The hypobromous acid formed in the reaction of BCDMH with water diffuses through the cell membrane disrupting cell metabolism leading to the death of the microorganism¹⁷. Hypobromous acid and hypobromite can react with natural organic matter, such as humic acids or other organic compounds naturally present in the source water, leading to the formation of disinfection by-products such as trihalomethanes and haloacetic acids. BCDMH is the most frequently used disinfectant in hot tub systems. The production of HOBr from a BCDMH tablet is slow, so a steady-state concentration of HOBr may be maintained over the course of several days after the addition of the tablets to the

water. Further DBP formation may be the result of previously formed DBPs reacting further with the disinfectant as they recirculate in the water system^{17,176}.

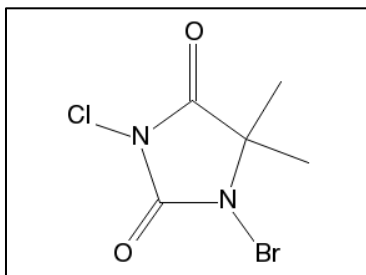
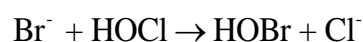
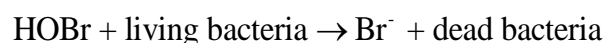
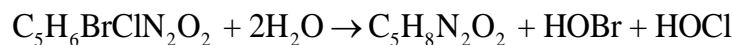

Figure 17. The structure of 3-bromo-1-chloro-5,5-dimethylhydantoin (BCDMH).



Scheme 6. The reaction of BCDMH during the disinfection process.

THMs and HAAs, which are monitored by the EPA, are frequently detected in aquatic facilities^{61,62}. The prevalence of respective halogenated species is dependent on the chemicals used for disinfection. Large aquatic facilities, such as water parks and public swimming pools, use chlorine based disinfectants, so the chlorine containing DBPs are the most abundant. Conversely, for hot tubs where bromine containing disinfectants are normally used, brominated DBPs predominate. Of the four common THMs (chloroform, dichlorobromomethane, chlorodibromomethane, and bromoform), bromoform (CHBr_3) is the most frequently detected in hot tubs when BCDMH was used as the disinfectant⁶². Bromoform exhibits similar toxicological endpoints as chloroform^{50,177}, such as carcinogenicity, though at lower concentrations. To date, the formation of higher molecular weight products (larger than CHBr_3) produced by BCDMH in water have not been studied.

There are several reasons for the interest in analyzing DBPs isolated from hot tub water. First, individuals using a hot tub may be exposed to large concentrations of potentially toxic compounds. These toxic compounds may be discharged into aquatic environments causing ecosystem damage. Second, the identification of specific DBPs in hot tub water allows for the determination of these compounds in natural water samples using targeted analyses. Finally, the mechanism of brominated DBP formation is also of interest. Knowledge of such a mechanism may permit us to predict the structures of DBPs formed by other reagents. Experiments were conducted to test the hypothesis that many of the major disinfection by-products formed in hot tub water may be the result of hydrolysis or unimolecular decomposition of the disinfection reagent itself. The hypothesis would be valid if the major ions observed in the mass spectra of both the water extracts from the hot tub and those of ultra-pure water were the same. If this is the case, identification would become easier as the range of possible empirical formulas becomes narrower.

Nine water samples from the hot tub in the Norville Center for Intercollegiate Athletics on Loyola University's Rogers Park campus in Chicago, IL were collected over an eight month period between October 2014 and May 2015 at different times. Hot tub samples were also collected in the mid-morning over a two week period between July 27, 2015 and August 7, 2015 on Monday, Wednesday, and Friday at approximately the same time on each day to see if the concentrations of the DBPs changed with time over the course of the week. The water for the hot tubs was replaced each Saturday. BCDMH decomposition studies were carried out at 45°C in ultra-pure water to determine if

chemical transformations via hydrolysis, decomposition, or reactions between degradation products of the BCDMH disinfectant occurred. Sample analysis was performed using GC-ECD and mass spectrometry.

GC-ECD Analysis

GC combined with electron capture detection (ECD) was used for the analysis of low molecular weight DBPs, particularly THMs and HAAs. ECD is particularly sensitive for the analysis of halogen-containing compounds as the electron withdrawing groups allow for the capture of electrons generated in the source. Pentane extracts of hot tub water indicated the presence of bromoform. The low abundance of dibromochloromethane in the hot tub extract suggests that bromodichloromethane and chloroform also contribute negligibly to the total THM concentration in hot tubs treated with a bromine-containing disinfectant (Figure 18). This result also suggests that more highly chlorinated DBPs are unlikely to be formed in hot tub water treated with BCDMH. This result alone was not entirely unanticipated. The hot tubs are treated with a bromine-containing disinfectant. Thus, higher concentrations of bromine DBPs were anticipated. However, bromoform was the major component detected. Liquid-liquid extraction was anticipated to provide a broad range of analytes, but no other components were observed. Bromoform is usually the least concentrated analyte present of the four common THMs. The analysis of the hot tub water indicates a concentration in the range of 300 to 400 ppm, well over established EPA allowable concentrations of 0.080 mg/L (80 ppb). These limits may be established for drinking water, but given the high concentrations observed in hot tubs one could wonder about what health risks exist associated with the acute

exposure to bromoform at these concentrations. The high levels of bromoform present in hot tub water suggests that hot tubs treated with BCDMH are a large contributor to bromoform in the environment. These results also encouraged the analysis of hot tub water for high molecular weight, halogenated compounds.

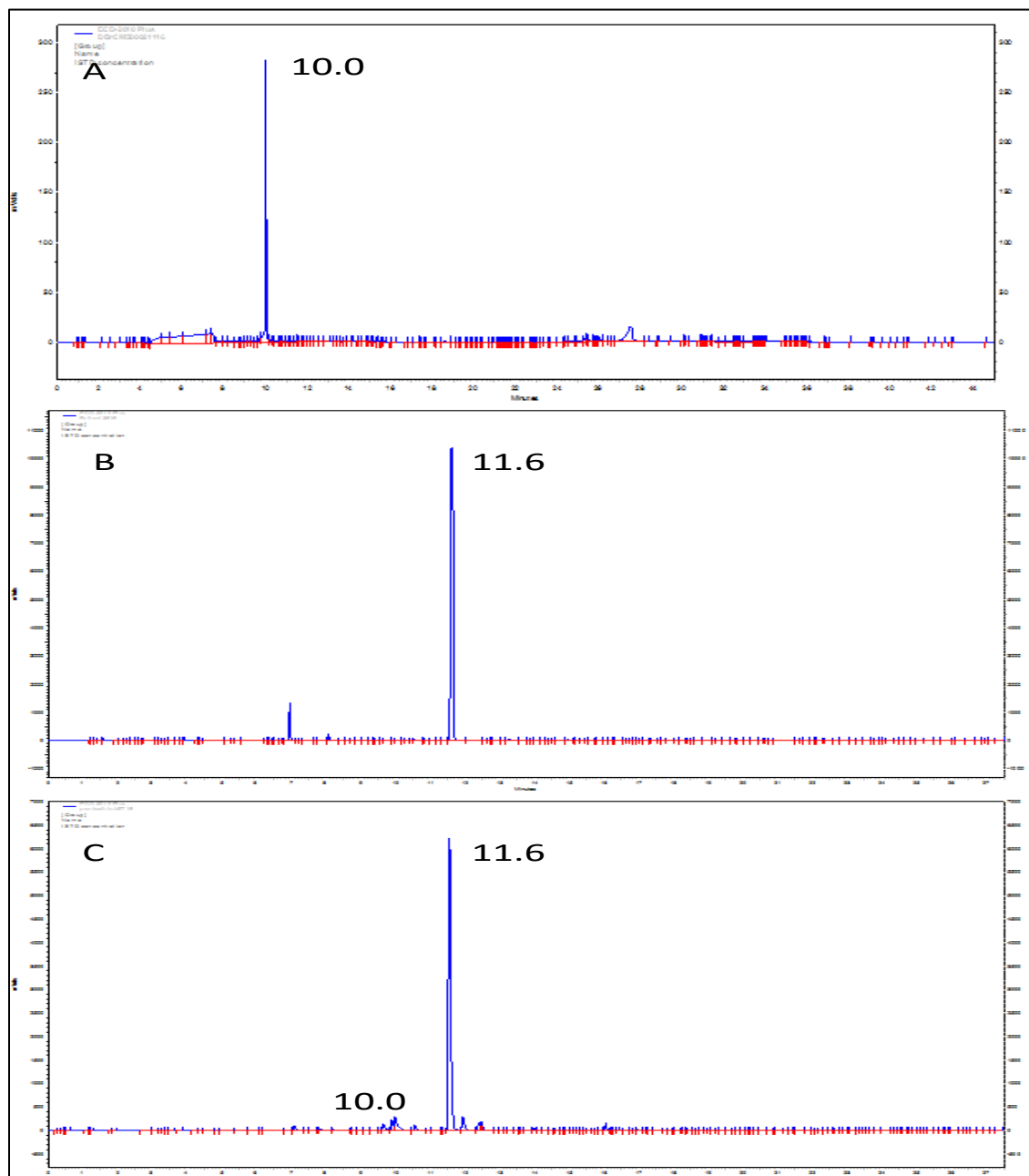
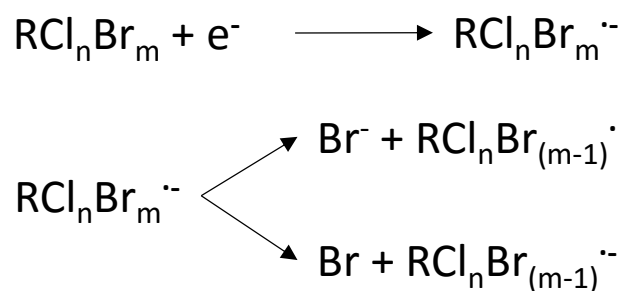

Figure 18. GC-ECD chromatograms of (A) dibromochloromethane, (B) bromoform, and (C) an extract of hot tub water.

TD-NCI-TOF-MS Analysis

Thermal desorption negative chemical ionization time of flight mass spectrometry (TD-NCI-TOF-MS) was used as a “broad brush” analysis approach for halogen-containing compounds. NCI is known to be a sensitive and selective method for creating negative ions from compounds containing electron-withdrawing groups (e.g. halogens, nitro groups, cyano groups, etc.)^{178,179}. TD-NCI coupled with time-of-flight mass spectrometry is well suited for the analysis of halogen-containing compounds of unknown molecular weight due to the sensitivity of the method. Analysis based on direct thermal desorption are more desirable than conventional GC/MS in some cases because many high molecular weight compounds may require long periods of time (hours) to pass, if at all, through a conventional 15 meter column. If these compounds lack acidic or basic functional groups, LC/MS analysis based on ESI may not be feasible. When the sample is desorbed from the probe, brominated species can easily be ionized through the capture of low energy electrons leading to the detection of the molecular ion and/or structure-specific fragment ions formed in the sources of the mass spectrometer (Scheme 7). TOF-MS can carry out an unknown molecular weight determination with better sensitivity and mass accuracy than conventional quadrupole mass analyzers. Quadrupole mass analyzers analyze a single m/z value at a time and typically have only unit mass resolution. Thus, the combination of these desorption, ionization, and mass analysis methods (TD-NCI-TOF-MS) is well suited for the analysis of a greater number of compounds than other mass spectrometry based methodologies at our disposal.



Scheme 7. The ionization and possible fragmentation of a halogenated compound in TD-NCI.

Hot tub samples acquired over the course of approximately eight months were found to contain a number of mono- and dibrominated compounds. The presence of bromine-containing compounds was inferred from the presence of m/z 79 and m/z 81 ions in the mass spectra of all extracts with exact masses matching those of the two bromine isotopes. The isotope ratio of these peaks was 1:1 further indicating the likelihood of bromine-containing compounds being present in the sample (Figure 19). It is possible that different combinations of C, H, N, and O will lead to masses of 79 and 81 Daltons. However, the extracted ion chromatograms for these masses have similar shapes and ion abundances (Figure 20). Figure 20 indicates a prevalence of bromide ions from minutes 3 through 6 and it is here where the majority of brominated compounds might be expected to desorb. With the approximate 1:1 peak ratio seen in the mass spectra of the samples and the similarities observed in the extracted ion chromatograms, the presence of bromine-containing compounds is strongly supported.

Identification of brominated ions was performed by first identifying which regions of the total ion chromatogram resulted in a maximization of signal for both ^{79}Br and ^{81}Br ions. These regions of the total ion chromatogram were then split into small

time segments of approximately one minute each and a mass spectrum was extracted from each segment. The resulting mass spectra from the small time segments were then analyzed over small mass ranges for the characteristic isotope patterns for bromine-containing ions.

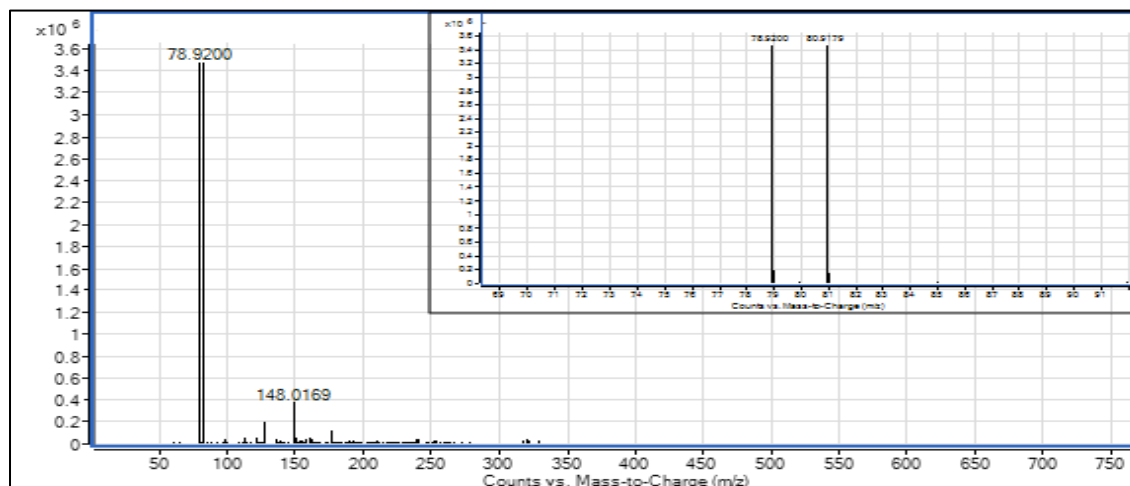

Figure 19. TD-NCI-TOF-MS full scan mass spectrum averaged over minutes 4-13 (inset showing exact isotope masses).

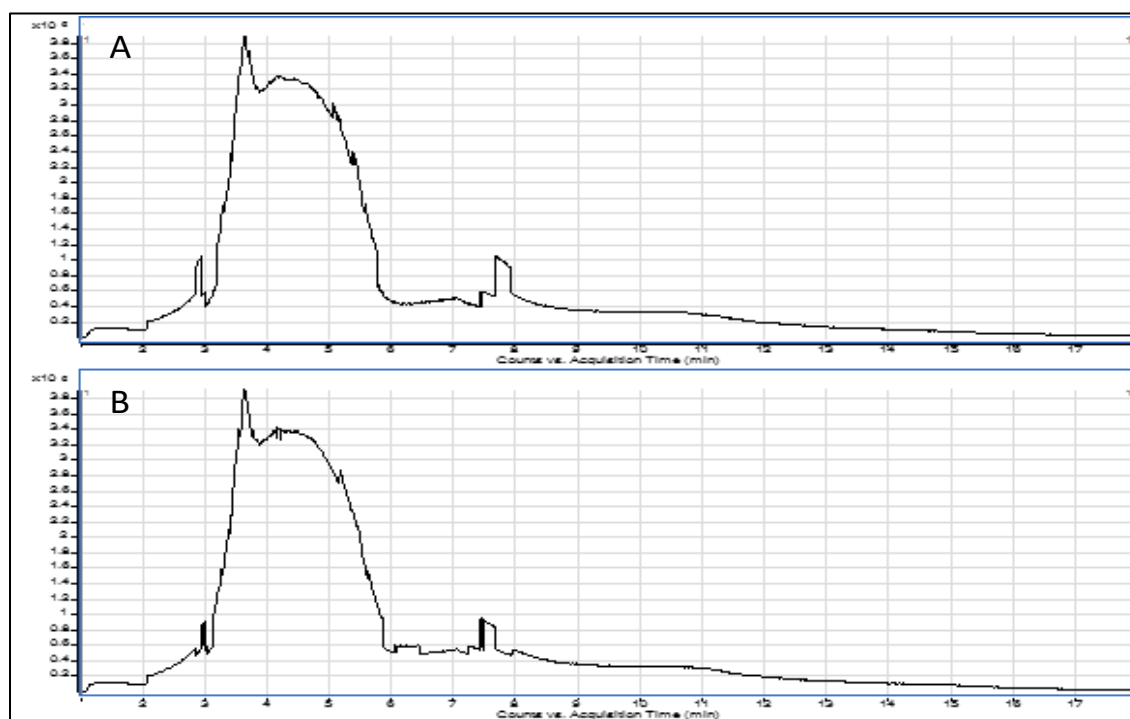

Figure 20. TD-NCI-TOF-MS extracted ion chromatogram for (A) m/z 79 and (B) m/z 81.

The analysis of three hot tub samples collected on different days over an eight month period indicated the presence of three consistently observed ion pairs at m/z 135.9/137.9 (scans averaged between six and seven minutes), m/z 175.9/177.9 (scans averaged between six and seven minutes) and m/z 189.9/191.9 (scans averaged between five and six minutes). The isotope ratios of these ion pairs are indicative of monobrominated compounds (Figures 21-23).

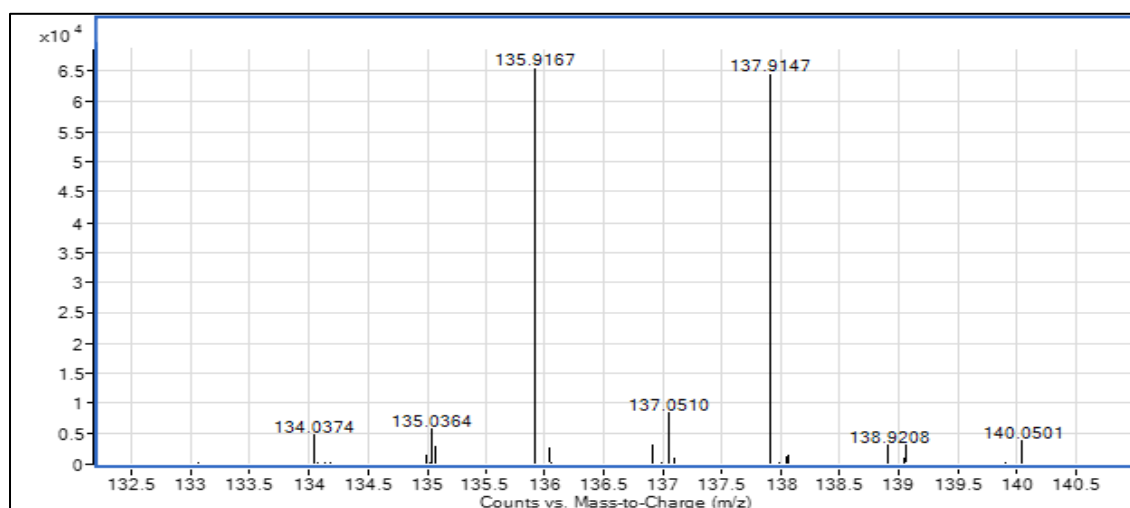

Figure 21. Mass spectrum of a monobrominated compound having monoisotopic masses at m/z 135.9167 and m/z 137.9147.

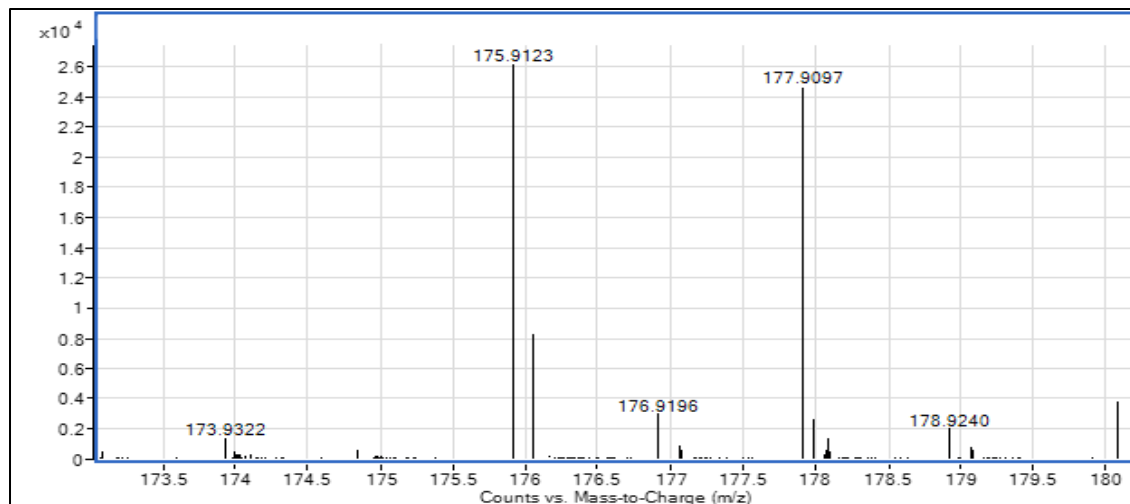

Figure 22. Mass spectrum of a monobrominated compound having monoisotopic masses at m/z 175.9123 and m/z 177.9097.

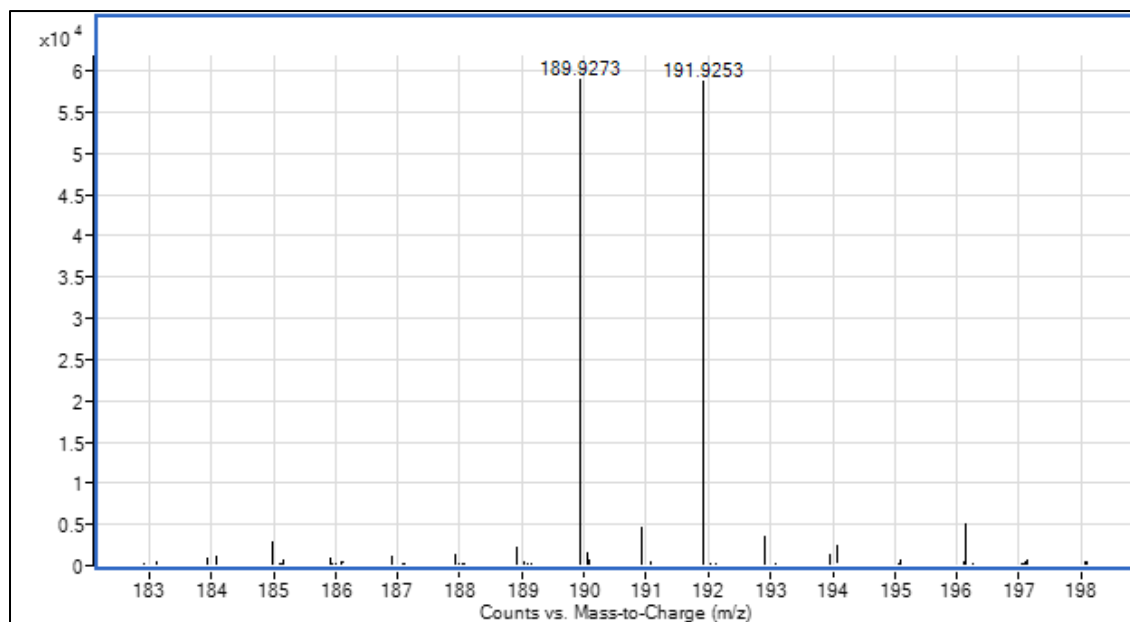

Figure 23. Mass spectrum of a monobrominated compound having monoisotopic masses at m/z 189.9273 and m/z 191.9253.

It is possible that these three ion pairs form from the same precursor ion. The mass difference between m/z 175.9 and m/z 189.9 is approximately 14 Daltons, consistent with a CH_2 (14.0157 Daltons, 49.9 ppm mass error) group. It is possible that these two ions are formed from the same precursor ion through bond cleavage on either side of the CH_2 carbon.

Approximately 40 Daltons separate the m/z 175.9 and m/z 135.9 ions, and there is an approximately 54 Dalton difference between m/z 189.9 and m/z 135.9. The most likely empirical formulas associated with these mass fits are C_2O (39.9949 Daltons, 17.5 ppm mass error) and $\text{C}_3\text{H}_2\text{O}$ (54.0106 Daltons, 0 ppm mass error). However, these empirical formulas do not correspond to commonly observed mass losses¹⁴⁰. A mass loss of 54 Daltons could correspond to sequential losses of acetylene and CO, but the absence of any species formed by the loss of 26 or 28 Daltons does not support this

conclusion. It appears unlikely that m/z 135.9 forms from the same precursor ion as m/z 175.9 or m/z 189.9. This is supported by the desorption profiles associated with these ions shown in Figure 24. The differences in peak shape and abundances indicate the formation of these three ion pairs are likely coming from different precursor ions. All three desorption profiles show maxima between six and eight minutes and between twelve and fourteen minutes.

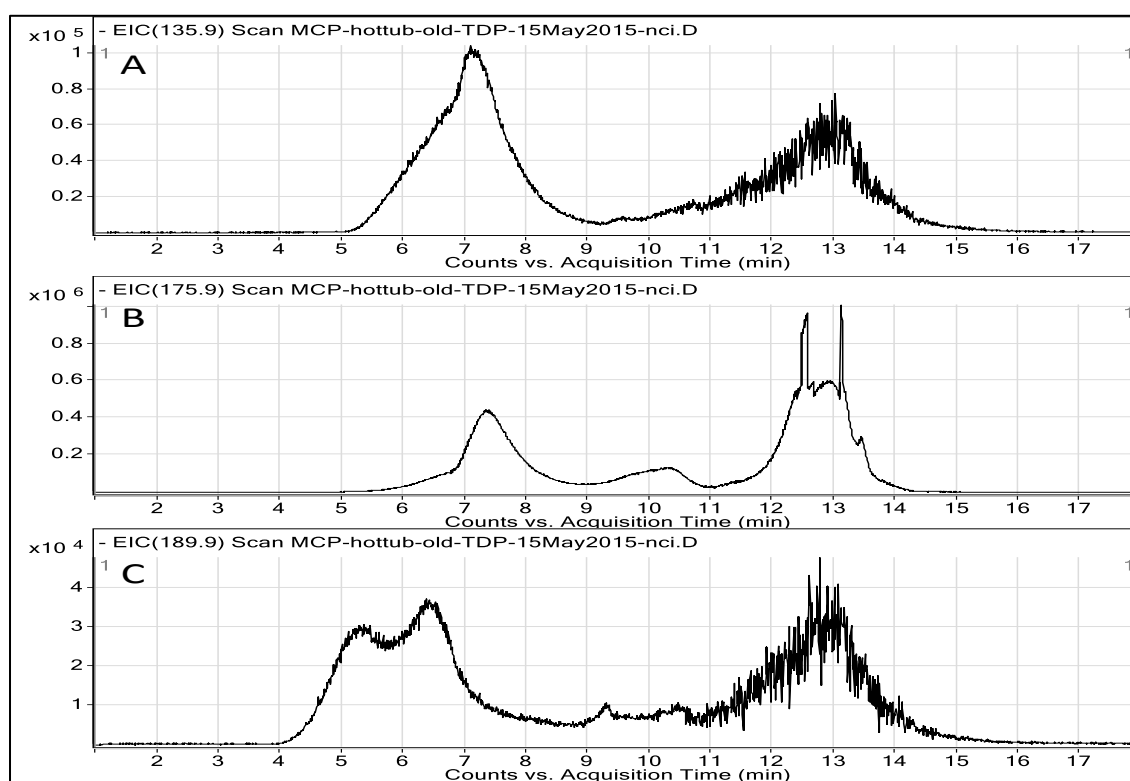

Figure 24. TD-NCI-TOF-MS extracted ion chromatograms for the (A) m/z 135.9 ion, (B) m/z 175.9 ion, and (C) m/z 189.9 ion.

The presence of several peak maxima observed in the desorption profiles (Figure 24) strongly suggests that there may be more than one precursor ion or isomer associated with the observed ions. The mass spectra associated with the desorption profile maxima observed in Figure 24 were analyzed for the purpose of determining if

the observed ions were molecular ions or fragment ions formed from a higher molecular weight precursor. Mass spectra were extracted from individual scans averaged over a one to one and a half minute time frame over the maxima observed in the three extracted ion chromatograms in Figure 24. The resulting mass spectra were interrogated over the 200-750 Daltons mass range for the characteristic isotope pattern for ions containing one or two bromine atoms.

The mass spectra averaged from scans collected between 6.4 and 7.7 minutes indicated the presence of a dibrominated ion at m/z 214.8/216.8/218.8 (Figure 25). The m/z 214.8 ion is 79 Daltons more than that observed at m/z 135.9. The desorption profiles of both the m/z 135.9 and m/z 214.8 ions are similar (Figure 26) indicating that the m/z 214.8 ion is likely the parent ion which fragments bromide leading to the formation of at least some of the m/z 135.9 ion.

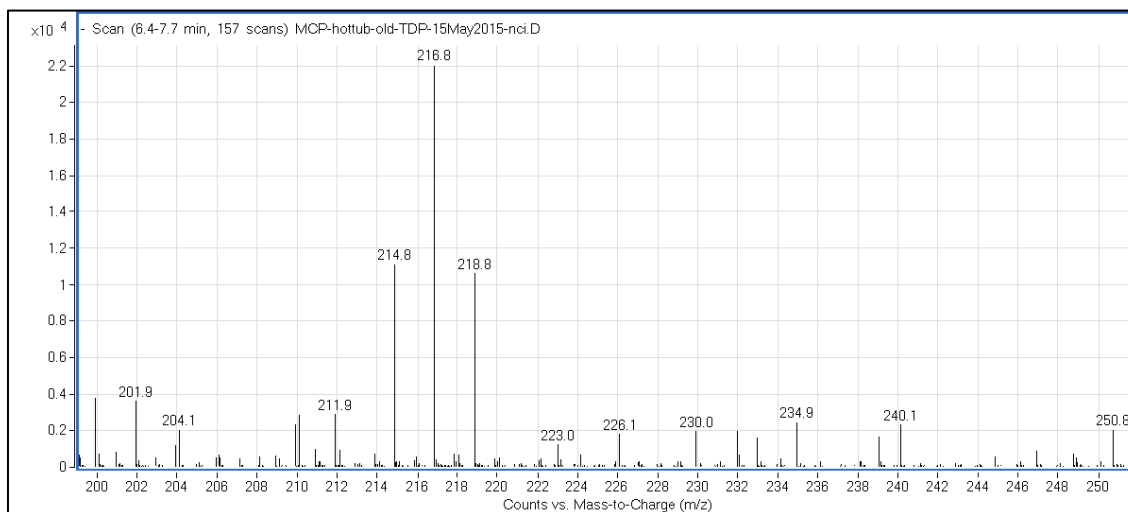

Figure 25. Mass spectrum of a dibrominated compound having monoisotopic masses at m/z 214.8337, m/z 216.8317 and m/z 218.8296.

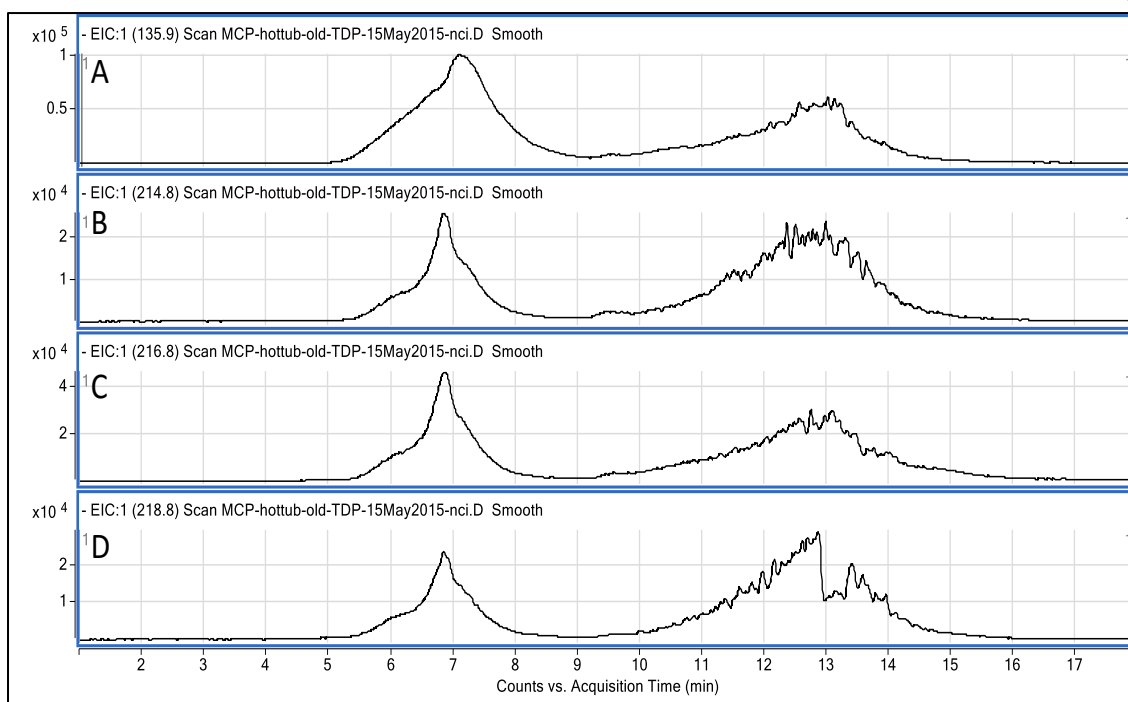

Figure 26. TD-NCI-TOF-MS extracted ion chromatograms for the (A) m/z 135.9 ion, (B) m/z 214.8 ion, (C) m/z 216.8 ion, and (D) m/z 218.8.

The m/z 214.8 ion is also present at maxima present in the extracted ion chromatogram of the m/z 175.9 ion. However, it is unlikely that m/z 175.9 is a product ion as the mass difference is 39 Daltons which may form from the loss of C_3H_3 . If this were the fragment lost to form m/z 175.9, the isotope pattern for m/z 175.9 would indicate the presence of a dibrominated ion, but a monobrominated ion is indicated. The desorption profiles of these two ions are also not similar. This ion pair is likely a molecular ion as no higher molecular weight brominated species were observed which gave an indication of fragmenting to form the ion observed at m/z 175.9.

The presence of the m/z 214.8 ion is observed in mass spectra extracted from maxima of the m/z 189.9 ion as well. This mass difference is 25 Daltons which has no logical ions. Further, the desorption profiles of these two ions are not similar. As

observed with the m/z 175.9 ion, no other higher molecular weight ions were observed which gave an indication of fragmenting to form the m/z 189.9 ion. This ion is likely a molecular ion.

Empirical Formulas of Fragment Ions and Potential Precursor Ions

Formula fitting using ChemCalc¹⁴⁹ yields several formulas for each ion pair. The empirical formula observed at m/z 135.9/137.9 is C_2HBrO_2 with a 2.9 ppm mass error. One structure was found to match the formula. Other formulas which may have fit included those for the butyl bromide isomers (C_4H_9Br) and C_3H_5OBr . These last two formulas are proposed as the masses observed are 57 Daltons higher than just bromine. If the ion is derived from the BCDMH disinfectant, the latter formula seems more likely. However, the mass error was too great for each of these two ions as it was in excess of 250 ppm. The isotope ratio for ^{13}C in the mass spectrum gave no additional information as it ranged from 7-20% likely due to interfering ions. Thus it seems that the initial formula proposed is a likely match possibly coming from the decomposition of the BCDMH disinfectant. The proposed formula was found to fit the compound 2-oxoacetyl bromide (Figure 27) which has been proposed as an intermediate in atmospheric oxidation of 1,2-dibromoethane¹⁸⁰.

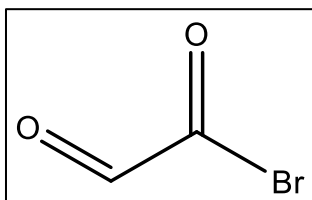

Figure 27. The structure of 2-oxoacetyl bromide.

The indication that the m/z 214.8/216.8/218.8 ions are the molecular ion which fragments to form the m/z 135.9/137.9 ion pair leads to the proposed empirical formula of $C_2HBr_2O_2$ (theoretical mass: 214.8348 Daltons, observed mass: 214.8337 Daltons, 5.2 ppm error) for the molecular ion. The theoretical isotope distribution and that which is observed fits well with this proposed formula. This formula fits with the deprotonated form of dibromoacetic acid. The absence of a dibrominated ion at m/z 170.8/172.8/174.8 from the common loss of CO_2 (44 Daltons) for carboxylic acids (as seen in the LCMS spectra below) suggests that this ion is formed from an isomer of dibromoacetic acid. A structure search suggests that these dibrominated ions may be formed from an alcohol (Figure 28). The 1,2-dibromo-2-oxoethoxy radical (Figure 28) has been observed as an intermediate in the atmospheric oxidation of 1,2-dibromoethane¹⁸⁰, suggesting that an alcohol structure formed by the attachment of a hydrogen atom may be stable. It is known that free radicals formed by the oxidation of 1,2-dibromoethane may be formed in solution as well¹⁸¹. Such a free radical structure is resonance stabilized. The alcohol isomer of dibromoacetic acid may desorb from the probe and lose a hydrogen atom upon electron capture to ultimately yield a closed-shell negative ion.

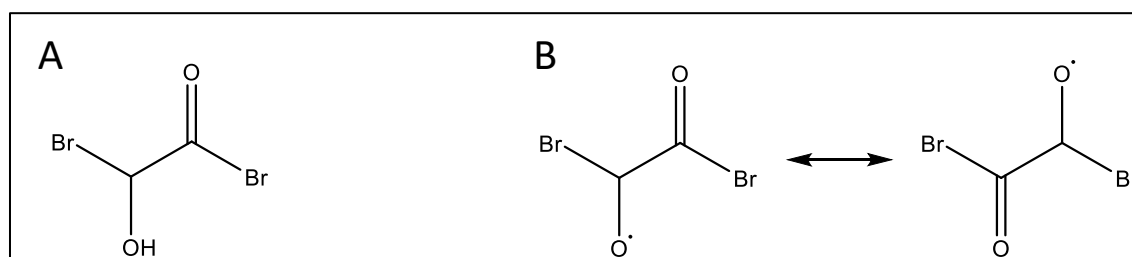

Figure 28. (A) The structure of 1,2-dibromo-1-hydroxy-2-oxo-ethane and (B) the resonance stabilized 1,2-dibromo-oxoethoxy radical.

The observation of these ion masses supports the proposed ionization mechanism via competing reactions involving inductive cleavage leading to the formation of either the bromide ion (as can be observed in Figures 19 and 20) or the formation of the radical anion of the molecular ion and observed fragment ions (as discussed here).

The ion pair observed at m/z 175.9/177.9 gives a formula match of C_4HBrO_3 (theoretical mass: 175.9114, observed mass: 175.9123, 5.2 ppm mass error) having only one structure to match the formula. The proposed structure for this ion pair is 3-bromo-2,5-furandione (Figure 29). This compound may be present as a brominated DBP of maleic anhydride. The introduction of maleic anhydride into the hot tub environment may be coming from the source water or through chemicals rinsing off individuals using the hot tub. The bromine is freely available in the water from the disinfectant.

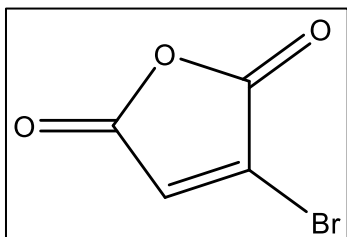

Figure 29. The structure of 3-bromo-2,5-furandione.

Finally, the ion pair at m/z 189.9/191.9 has a formula fit of $C_5H_3BrO_3$ (theoretical mass: 189.9271, observed mass: 189.9273, 1.1 ppm mass error). This formula has structural matches for the six isomers of bromofuroic acid, 3-bromo-5-hydroxy-4H-pyran-4-one, 2-bromo-3-hydroxy-4H-pyran-4-one, 3-bromo-4-methyl-2,5-furandione, and 3-bromomethyl-2,5-furandione (Figure 30). The last compound is one methylene group different in structure from that proposed for the ion pair observed at m/z

175.9/177.9. However, as discussed above, this structure does not appear to be a likely candidate. Furoic acids, particularly 2-furoic acid, have been used as preservatives, bactericides, and fungicides. The addition of a bromine atom from BCDMH to furoic acid in BCDMH-treated hot tub water may occur leading to the formation of the bromofuroic acid isomers.

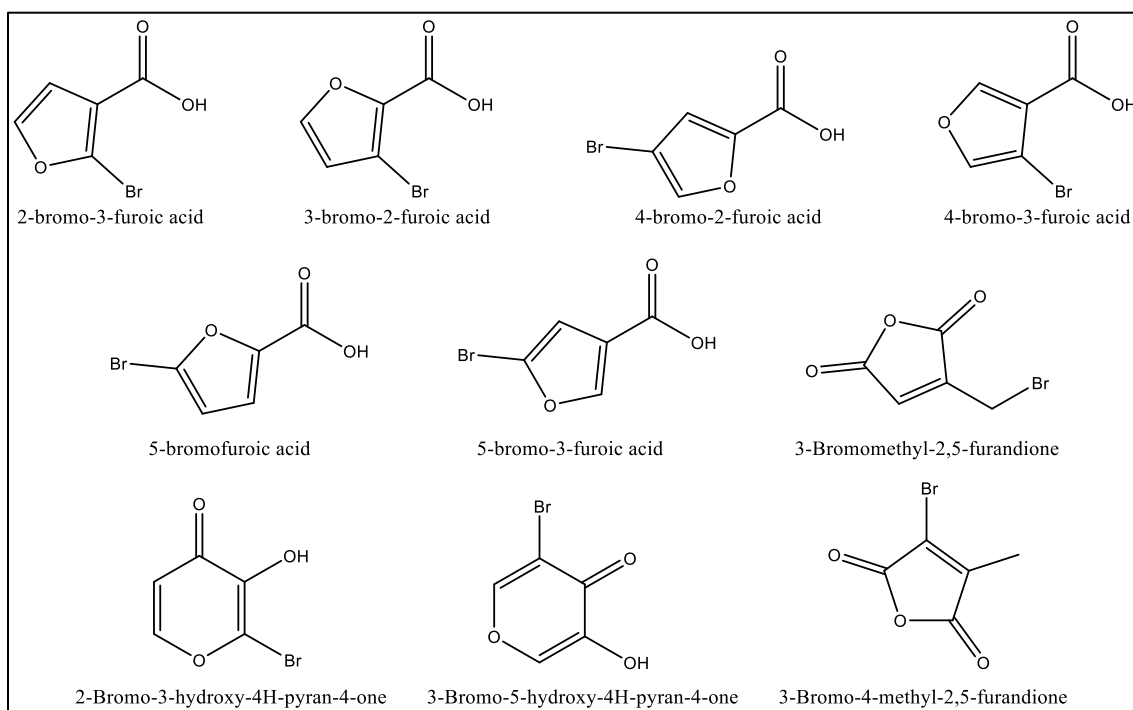

Figure 30. The proposed structures matching the formula $C_5H_3BrO_3$.

LCMS analysis on a triple quadrupole instrument did not provide evidence of the carboxylic acids however.

LC-TOF-MS Analysis

Hot tub samples were collected over the course of a week on Monday, Wednesday and Friday. Two ion clusters observed at m/z 170.8/172.8/174.8 and those at m/z 214.8/216.8/218.8 were observed in the Monday and Friday samples (Figure 31).

These are suggested to be dibromoacetic acid, a known DBP present in treated drinking

water. The ions at m/z 170.8/172.8/174.8 (theoretical mass: 170.8451 Daltons for $[M-H]^-$ ion, observed mass: 170.8453 Daltons, 1.2 ppm mass error) are presumed to be the decarboxylated dibromoacetic acid ions resulting from in-source fragmentation. The lack of this ion from the Wednesday sampling may be a result of the dynamic nature of the hot tub system. It may be possible that the dibromoacetic acid reacted with other organic compounds present in the water to form other DBPs. These other DBPs may have further reacted to eventually reform dibromoacetic acid over the course of the week.

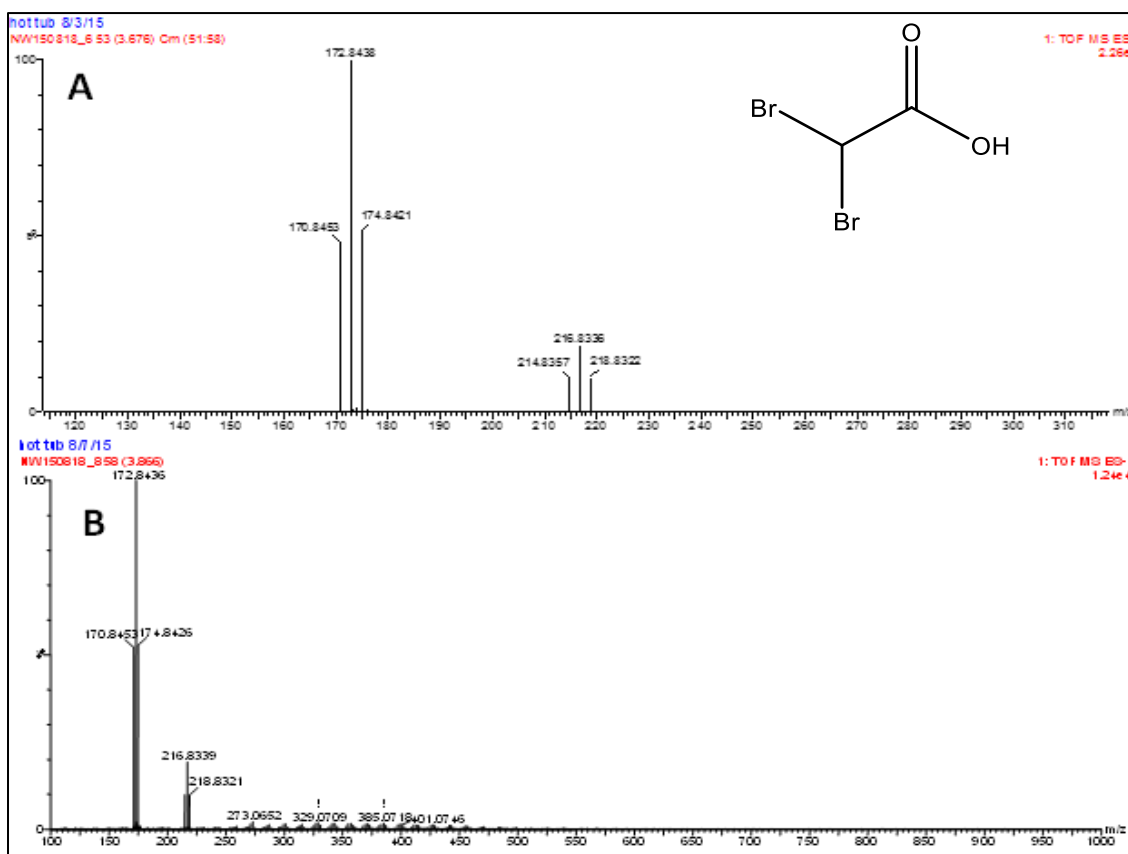

Figure 31. LC-TOF-MS full scan of dibrominated ions at m/z 170.8/172.8/174.8 and m/z 214.8/216.8/218.8 from the hot tub sample collected on (A) Monday (with the structure of dibromoacetic acid inset) and (B) Friday.

The presence of dibromoacetic acid in hot tub water treated with brominating disinfectants has not been extensively studied. Dibromoacetic acid was not observed in pools treated with chlorinating disinfectants⁶¹. In another study, dibromoacetic acid was observed in one of two pool water samples treated with a bromine-containing disinfectant. Five additional pools that were treated using chlorination also had detectable levels of dibromoacetic acid⁶³. Bromine present in the source water may lead to the formation of bromine-containing DBPs⁶¹. No other studies have been identified which investigated the formation of dibromoacetic acid in pool or hot tub water treated with brominating disinfectants. This should be considered the first instance of dibromoacetic acid forming as a DBP in a hot tub water treated with a brominating disinfectant.

The presence of dibromoacetic acid in the environment may result from the disposal of BCDMH treated water. Samples from Lake Michigan taken after rainfall events indicate the presence of dibromoacetic acid (observed as the decarboxylated ion) (Figure 32). These samples were collected not more than 12 hours after a significant rainfall event from locations near sewer overflow outlets. The Chicago area sewer system is designed as a combined sewer system¹⁸². It is possible the dibromoacetic acid observed in Lake Michigan after a rainfall event is being washed out of the sewer system as part of an overflow event and into the lake. Dibromoacetic acid is not consistently observed in lake water, so these overflow events create brief areas of a high concentration of dibromoacetic acid, which in the aquatic environment may deleterious to the aquatic ecosystems. Dibromoacetic acid contaminated water may lead to the

leaching of dibromoacetic acid into the terrestrial ecosystems and further adverse environmental impacts. Dibromoacetic acid is known to be carcinogenic⁵⁰.

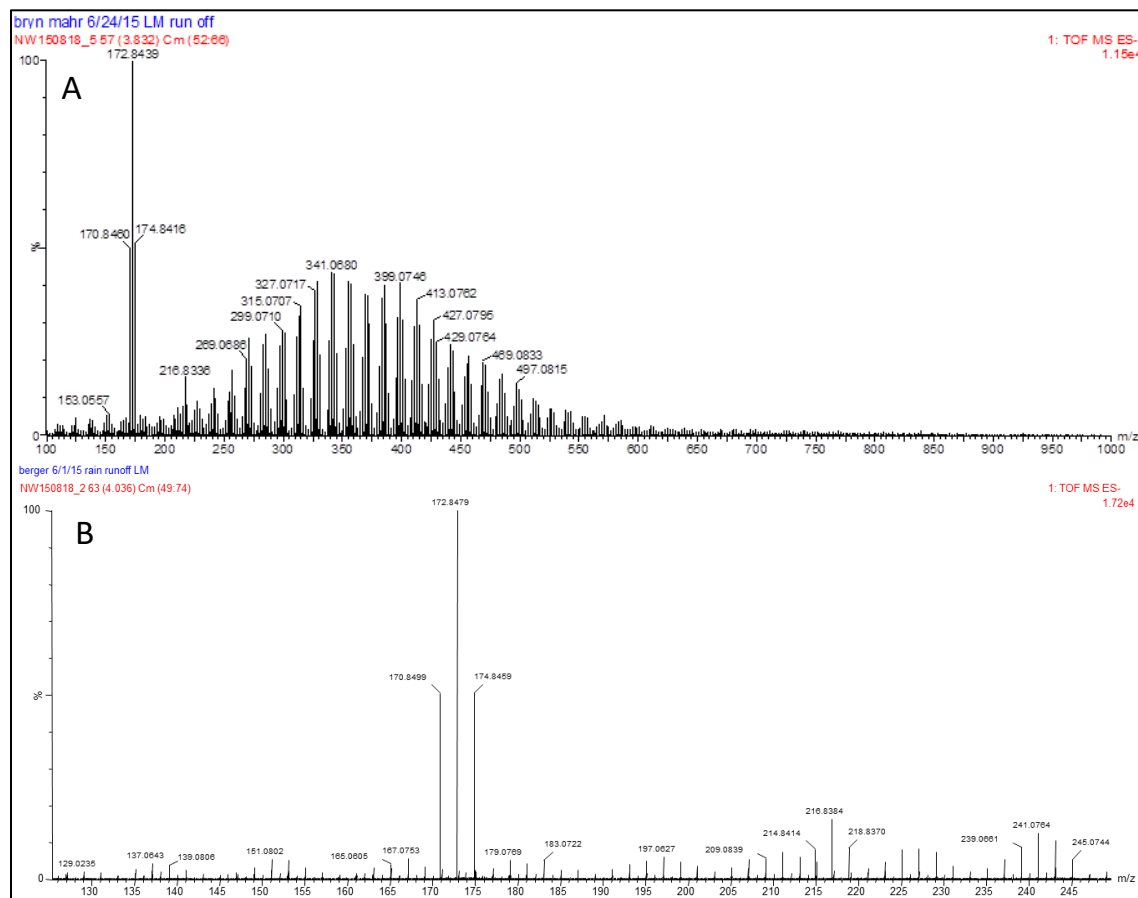

Figure 32. LC-TOF-MS full scan mass spectra of samples from Lake Michigan at (A) W. Bryn Mawr Ave. and (B) Berger Park indicating the presence of dibromoacetic acid.

Ions observed in only the Wednesday and Friday samples indicate that, over time, the composition of the water and the formed DBPs change. It may be that ions observed earlier in the week reacted further to form persistent DBPs and were thus intermediate DBPs. Those ions present in only samples from Monday and/or Wednesday only could thus be considered intermediates leading to the formation of persistent DBPs present in Wednesday and Friday samples. Of the ions observed on one or two of the three days, the monoisotopic masses of the ion trio clustered around m/z

240.8 observed in samples taken on Wednesday (Figure 33) and Friday were used to find possible formulas. The best formula fit was $C_3H_2Br_2N_2O$ (theoretical mass: 238.8461 Daltons for the $[M-H]^-$ ion, observed mass: 238.8456 Daltons, 2.1 ppm mass error) corresponding to two structures, one of which is 2,2-dibromo-2-cyanoacetamide (DBNPA) (Figure 34), a known biocide which can readily degrade to dibromoacetic acid among other products¹⁸³. The isotopic abundances for the A+1 peaks are consistent with the proposed formula as well after considering for the likelihood of instrument background and other potential interferences.

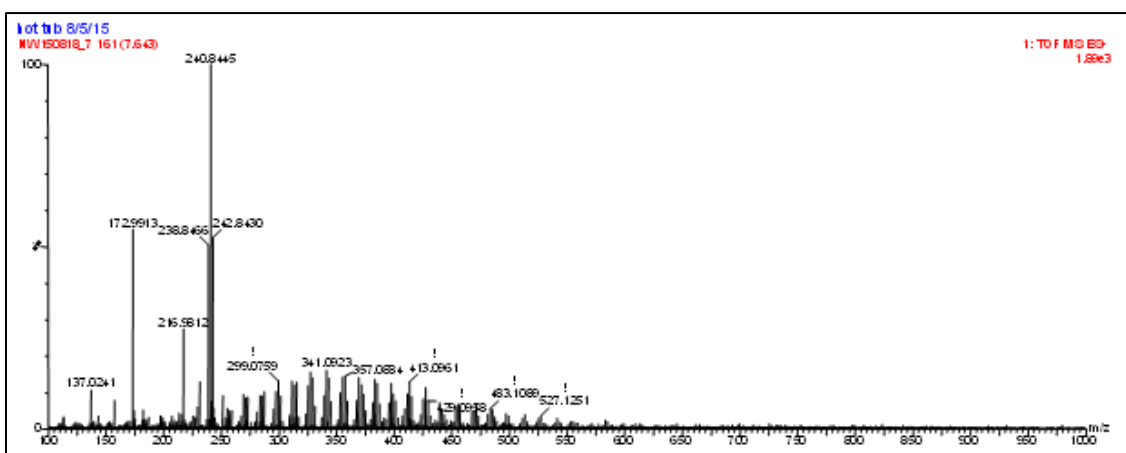

Figure 33. LC-TOF-MS full scan of a dibrominated ion at m/z 238.8/240.8/242.8.

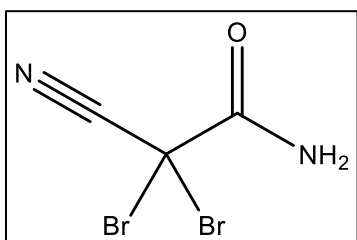

Figure 34. The structure of 2,2-dibromo-2-cyanoacetamide.

Ions at m/z 250.8/252.8/254.8, indicative of a dibrominated compound (Figure 35), were observed in all three of the samples acquired during the week. This compound

may be a persistent DBP or it may already be present in the source water as a DBP from the water treatment process.

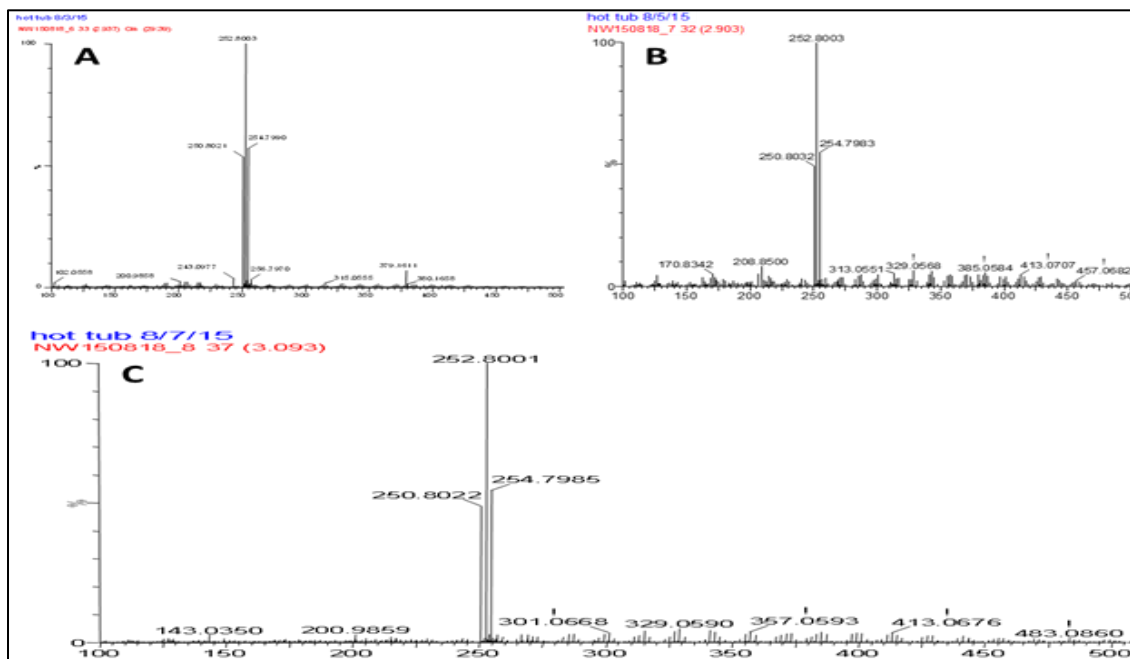

Figure 35. LC-TOF-MS full scan of a dibrominated ion at m/z 250.8/252.8/254.8 from the sampling of a hot tub on (A) Monday, (B) Wednesday, and (C) Friday in the same week.

The molecular formula $\text{CH}_2\text{Br}_2\text{SO}_3$ (theoretical mass: 250.8018 Daltons for the $[\text{M}-\text{H}]^-$ ion, observed mass: 250.8022 Daltons, 1.6 ppm mass error) is consistent with the ions observed at m/z 250.8/252.8/254.8 as the $(\text{M}-\text{H})^-$ ions for the isotope pattern indicative of two bromine atoms. The suggested formula fits with the structure for 1,1-dibromo-methanesulfonic acid (Figure 36). Other ions observed in the mass spectra of the sample indicated possible fragmentation of this compound, but the monoisotopic masses and retention times of those ions were not in agreement with the possible fragment ions which would likely be formed from 1,1-dibromo-methanesulfonic acid. It is uncertain from where this compound may be coming as the likely precursor, methanesulfonic acid, has not previously been observed in tap water. Methanesulfonic

acid has been detected in atmospheric aerosols, however^{184,185}. The bromination of methanesulfonic acid may occur by reaction of this compound with BCDMH or one of its hydrolysis products in hot tub water. To date, this appears to be the first time 1,1-dibromo-methanesulfonic acid has been observed as a DBP.

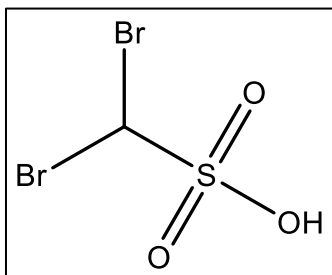

Figure 36. The structure of 1,1-dibromo-methanesulfonic acid.

Hydrolysis Studies of 3-Bromo-1-Chloro-5,5-Dimethylhydantoin (BCDMH)

The chemical transformation via hydrolysis, decomposition, or condensation reactions involving BCDMH in pure water was carried out to help identify brominated species observed in the NCI and ESI studies described above. The observation of ions with empirical formulas consistent with those observed in the studies discussed above would provide insight into how the DBPs in the hot tub water are formed and help determine their structures. The empirical formulas of the DBPs observed in the NCI and ESI studies all appear to have low carbon:hydrogen ratios, consistent with the empirical formulas of BCDMH. The empirical formulas of most bromine-containing DBPs determined in the NCI and ESI analysis are made up of the same atoms as BCDMH suggesting that BCDMH and/or water may be the sole precursors of the brominated DBPs.

The analysis of the ultra-pure water/BCDMH mixture yielded one consistent compound which was found to have an empirical formula fit within 5 ppm mass error. The compound observed at m/z 246.0/248.0 was fit to the formula $C_9H_3BrN_4$ (theoretical mass: 245.9546, observed mass: 245.9541, 2.1 ppm mass error) (Figure 37). A search for possible structures generated nine possible structures all of which have nitrile groups (R-CN) (Figure 38). Nitriles are found in a variety of consumer goods, such as glues (methyl cyanoacrylate), rubbers, and pharmaceuticals, as well as being naturally occurring compounds in plants and animals. Nitriles have been linked with possible negative health effects resulting from the release of cyanide in a reaction mediated by cytochrome P450¹⁸⁶.

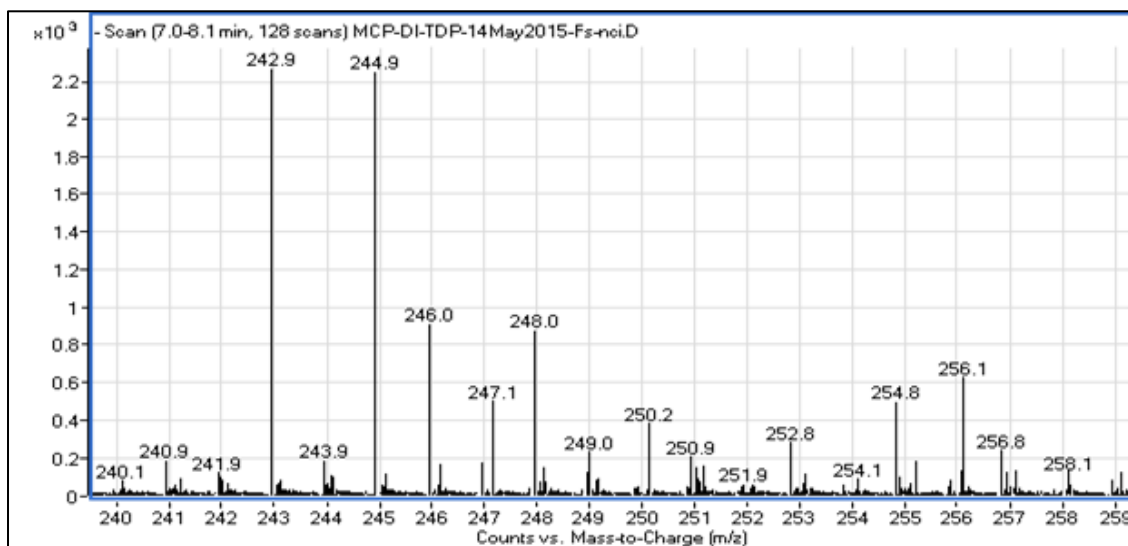

Figure 37. NCI-TOF mass spectrum of two monobrominated ions at (m/z 242.9/244.9 and m/z 246.0/248.0) from the 24 hour extract of BCDMH in ultrapure water.

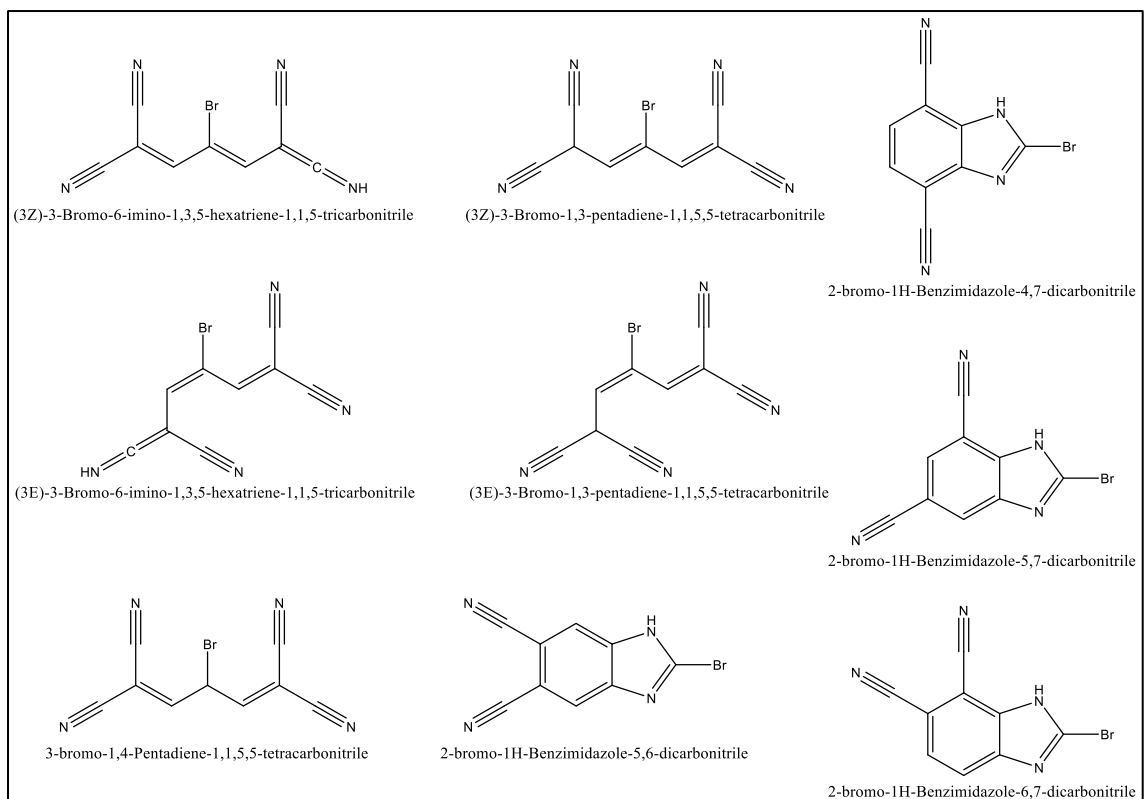

Figure 38. The nine structural matches for the formula $C_9H_3BrN_4$ that fit within 0.4 ppm mass accuracy.

The formation of nitriles in pool water is not unprecedented. Richardson et al.⁶³ identified five halonitriles in pool water. Bromoacetonitrile and bromochloroacetonitrile, however, were the only nitrile containing DBPs observed in pool water treated with a brominating disinfectant. Nitriles have also been observed in pool water treated with chlorinating disinfectants⁶¹. Bromine-containing disinfectants, however, are more likely to transfer its halogen leading to the formation of more bromine-containing DBPs than chlorine containing disinfectants. Nitrogen-containing organic precursors, such as amino acids and compounds found in urine, will likely react with bromine-containing disinfectants and form brominated DBPs in a manner similar to reactions with chlorinating disinfectants. The decomposition of these bromine-

containing nitriles will likely be slower than their chlorine containing analogs which presents a greater health risk due to their comparative stability⁵¹. However, the formation potential of nitriles and resulting reaction products in water treated with bromine-containing disinfectants has not been extensively studied.

The reactions with BCDMH in water taken from Lake Michigan indicated the presence of ion pairs at m/z 135.9/137.9 (observed after 7 days) and m/z 189.9/191.1 (observed after 24 hours) as had been also observed in samples taken from the hot tub. However, the desorption profiles of the lake water reactions do not match those of the hot tub sample. The ions present in the lake water reactions are likely different from those observed previously in the hot tub sample. These ions are likely isomeric to those observed in the hot tub samples. The differences in structure would lead to different desorption profiles while still having the same masses. The natural organic matter (NOM) present in the lake water likely reacted with the BCDMH to form these bromine-containing DBPs. The differences in the NOM in the lake water reactions and the hot tub would also contribute to differences in the structures observed.

Conclusion

The detection of bromoform in hot tub water was expected. However, the high abundance of bromoform observed is a concern. The minimal abundance of dibromochloromethane suggests that dichloro and trichloro THMs have a negligible contribution to the overall THM concentration observed in hot tubs treated with bromine-containing disinfectants. It is likely that highly chlorinated DBPs are unlikely to form in water treated with BCDMH. Bromoform is usually the least concentrated analyte

present of the THMs, but the observed concentration range, well above the EPA allowable concentration in drinking water, may be associated with an increase in health risks associated with bromoform exposure. The high concentration of bromoform also suggests that hot tubs may be large contributors to the bromoform load in the environment.

Hot tub samples analyzed using TD-NCI-TOF-MS indicated that at least two possible competing mechanisms contribute to the ionization reaction. The large abundance of m/z 79/81 coming from bromide is likely coming from the loss of bromine from lower molecular weight molecules and will not be observed in the mass spectrum. The formulas generated from the observed ions indicate that these suspected bromine-containing DBPs are oxygenated, which is not usually observed with chlorinated DBPs. The apparent presence of BrO_2^- and BrO_3^- ions suggest that these intermediates, which formed from the disinfectant and not the disinfectant itself, may be responsible for the oxidation of other compounds and microorganisms in the hot tub water.

Analysis of samples using LC-TOF-MS indicated the presence of dibromoacetic acid in hot tub samples. This observation is a first for the study of BCDMH. The presence of this compound in hot tub water should be of concern as it is a known carcinogen⁵⁰. Dibromoacetic acid was also observed in Lake Michigan after rainfall events. It is likely that the introduction of dibromoacetic acid to the environment is coming in part from overflow events. The presence of dibromoacetic acid in the environment may also be from the degradation of 2,2-dibromo-2-cyanoacetamide, a biocide that is known to degrade to form dibromoacetic acid. The presence of 2,2-dibromo-2-cyanoacetamide

was observed in hot tub samples in this study as well, and this is believed to be the first observation of this compound in such a matrix.

The identification of 1,1-dibromo-methansulfonic acid is also a first in hot tub water. Sulfonic acids have previously been observed in the environment but have not been studied in settings such as aquatic facilities¹⁸⁷.

The BCDMH hydrolysis study indicated that many of the proposed structures are nitriles. The abundance of nitriles in hot tub water should be concerning as many nitriles are known to be toxic and can potentially break down to form even more toxic compounds, such as HCN¹⁸⁶. Mechanisms for the formation of nitriles in water treatment have been proposed⁵¹. However, the presence of such compounds in hot tubs and pools has not been extensively studied despite several studies indicating their presence in pool water^{61,63}.

It does not appear to be the case that the major contributor to brominated DBPs in hot tubs comes from hydrolysis or unimolecular decomposition of the disinfection reagent itself as few ions were observed in all samples. It can be concluded that reactions involving only BCDMH are not major contributors to the DBPs observed in hot tub waters. Though the possibility that BCDMH reacts to form nitriles should be of concern. It appears that compounds already present in the source water or those introduced into the system from the bathers and further reaction with either free bromide or the disinfectant are the major routes leading to the formation of brominated DBPs in a hot tub system.

CHAPTER FIVE

STUDIES OF TRICLOSAN OXIDATION BY HYDROGEN PEROXIDE

Introduction

Triclosan (5-chloro-2-(2,4-dichlorophenoxy)phenol) (Figure 39) is a broad spectrum antimicrobial used in different formulations for disinfectants, soaps, detergents, toothpastes, mouthwashes, deodorants, and shampoos among other personal care products and veterinary, industrial, and household products¹⁸⁸. Triclosan acts on the bacterial cells by inhibiting the NADH or NADPH-dependent enoyl-acyl carrier protein reductase (FabI). Triclosan binds to FabI at the enoyl substrate site increasing the binding of FabI to NAD⁺. The formation of this complex inhibits the final steps of fatty acid elongation leading to cell membrane damage and dysfunction. The cell membrane damage leads to the eventual cellular death¹⁸⁹. It has also been shown that triclosan intercalates into bacterial cell membranes. The inclusion of triclosan in the cell membrane decreases its structural integrity and is hypothesized to contribute to the overall antibacterial effect of triclosan¹⁹⁰.

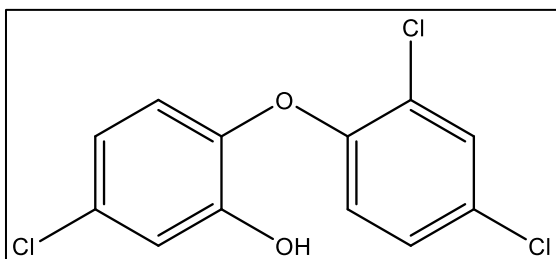

Figure 39. The structure of triclosan.

Triclosan is ubiquitous in the environment. It has been detected across the U.S. in streams as well as globally in various surface waters^{71,108}. Triclosan has further been observed in wastewater treatment plant influents and effluents around the world¹⁰⁸. For example, extractions of wastewater effluent from the Kirie and Stickney wastewater treatment plants in the Chicago are indicated the presence of triclosan. The theoretical and observed masses with respective mass errors for these two treatment plants are shown in Table 3. Triclosan has been detected in activated sludge from water treatment plants and sediment from rivers, lakes, and other bodies of water¹⁰⁸. Samples from the Stickney (Figure 40) and Kirie (Figure 41) wastewater treatment plants analyzed using LC-TOFMS indicate the presence of triclosan as a late eluting peak (approximately 26.8 minutes). Triclosan was also detected in samples from Lake Michigan near Berger Park in Chicago, IL using LC-MS-MS. The SRM analysis used clearly indicates triclosan eluting at 14.2 minutes (Figure 42). Though typically below limits of quantification and not frequently detected in tap water, triclosan has been observed in tap water or finished drinking water from the U.S., China, and across Europe^{108,191,192}.

Table 3. Triclosan molecular ion masses observed in extractions of Kirie and Stickney Wastewater Treatment Plant effluents.

Wastewater Treatment Plant	Theoretical Mass (Daltons)	Observed Mass (Daltons)	Mass Error (ppm)
Stickney	286.9439	286.9451	4.2
Stickney	288.9409	288.9427	6.3
Stickney	290.9380	290.9400	6.9
Kirie	286.9439	286.9486	16.4
Kirie	288.9409	288.9469	20.8

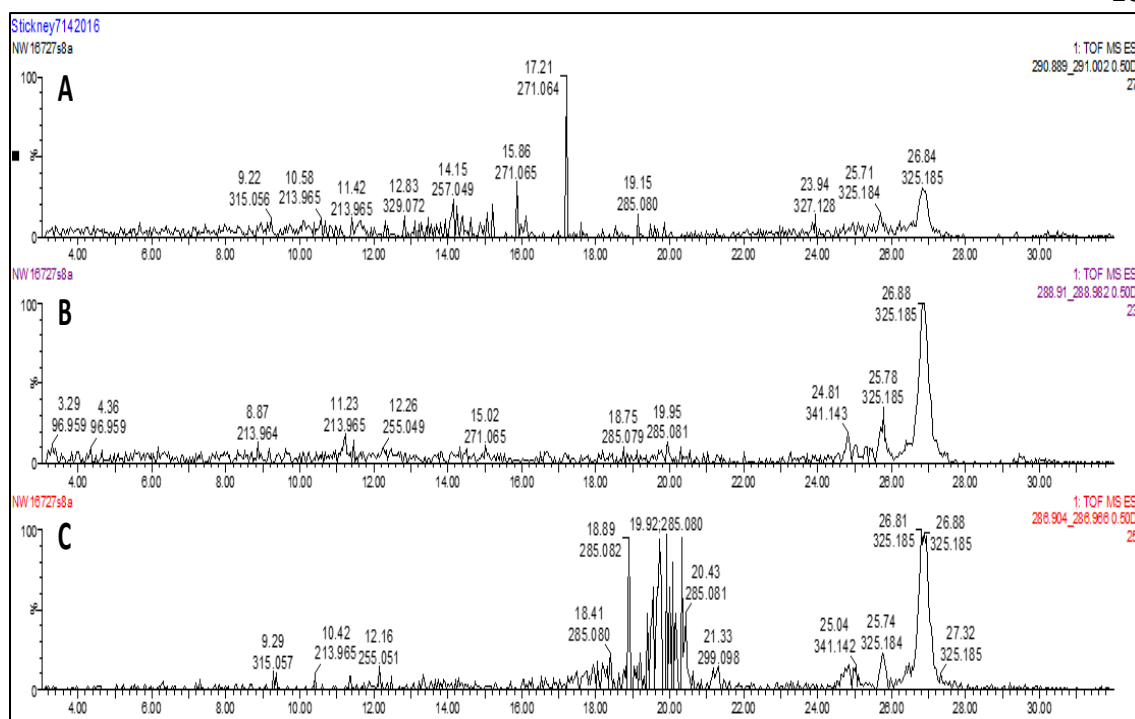

Figure 40. LC-TOFMS extracted ion chromatograms of the (A) m/z 290.9 ion, (B) m/z 288.9 ion, and (C) m/z 286.9 ion of the ^{35}Cl and ^{37}Cl isotopologues of triclosan.

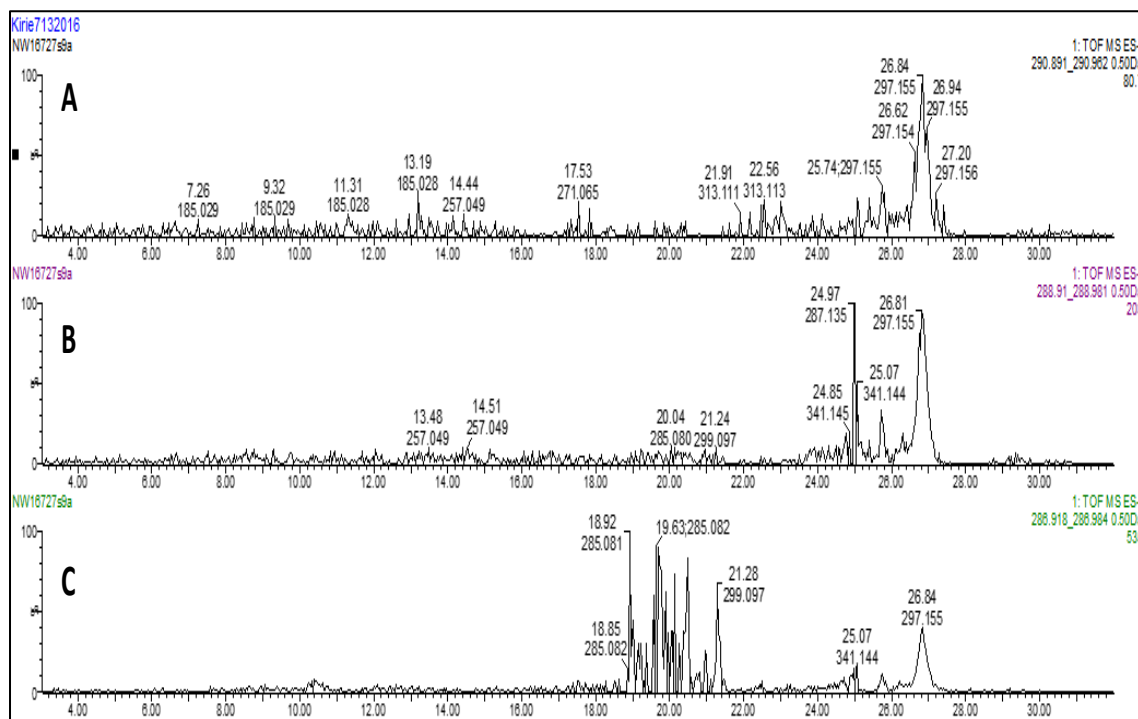

Figure 41. LC-TOFMS extracted ion chromatograms of the (A) m/z 290.9 ion, (B) m/z 288.9 ion, and (C) m/z 286.9 ion of the ^{35}Cl and ^{37}Cl isotopologues of triclosan.

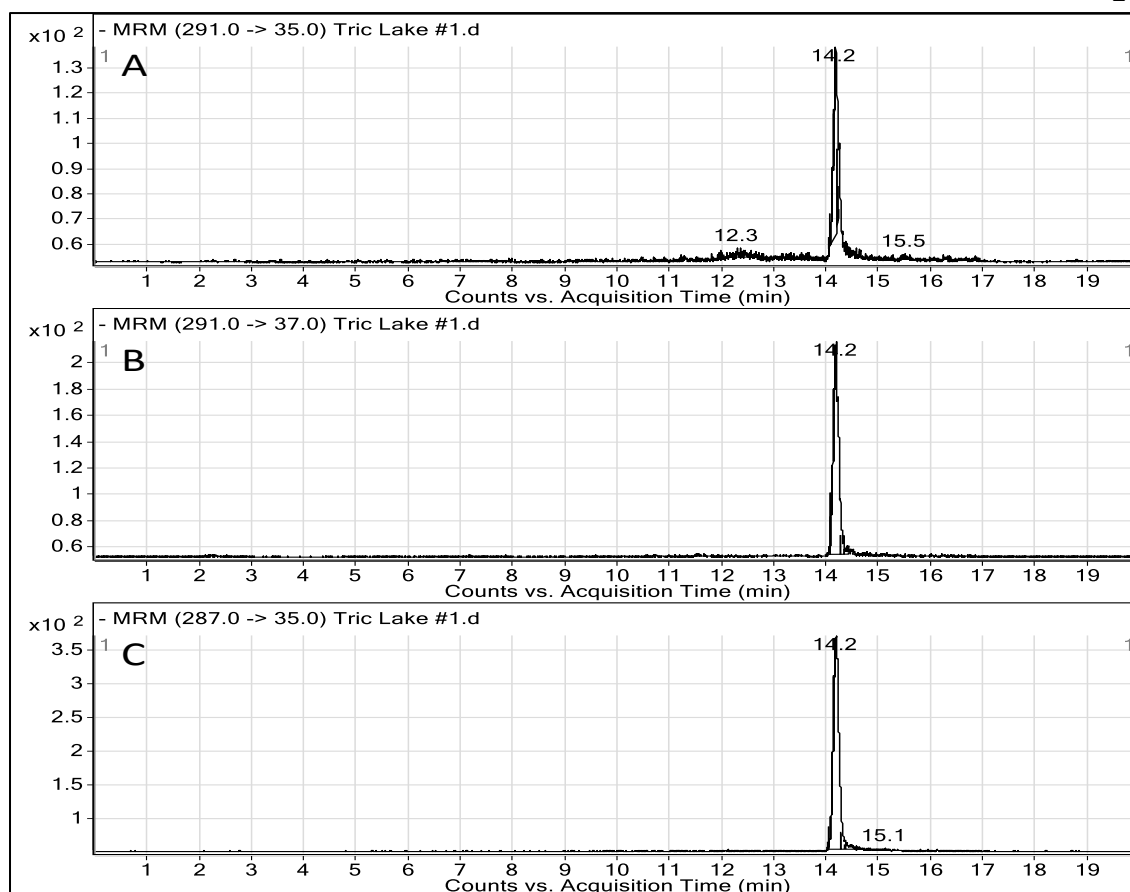

Figure 42. Extracted ion chromatograms indicating the presence of triclosan via the fragmentation of chlorine isotopes from selected isotopologues ((A) m/z 291 \rightarrow m/z 35, (B) m/z 291 \rightarrow m/z 37, and (C) m/z 287 \rightarrow m/z 35).

Humans are exposed to triclosan extensively through personal care products.

Triclosan has been widely detected in human blood and urine¹⁰⁶. Human exposure to triclosan is seemingly not preventable as it is widely used in personal care products.

Studies to determine the potential mechanisms of action of triclosan in humans indicate that triclosan is an endocrine disruptor¹⁹³. The toxicology of triclosan has been well studied in humans, and it is generally concluded that despite the evidence present for possible adverse health effects, triclosan is still safe to use.

The presence of triclosan in the environment should be of greater concern given its potential to cause damage in different ecosystems. Triclosan may undergo cleavage of the ether bond leading to the formation of 2,4-dichlorophenol and other chlorophenols. Other routes of triclosan decomposition may lead to the formation of other environmental phenols^{113,116}. There is evidence to suggest that the products of triclosan degradation are more toxic than triclosan alone^{108,194,195}. Redox reactions are likely to occur in the environment, and the aim here is to investigate how triclosan reacts upon oxidation using hydrogen peroxide. This reaction can feasibly occur when using common personal care products such as toothpaste, mouthwash, and teeth whitening systems. Triclosan can also be oxidized in treatment systems which employ advanced oxidative processes. This study seeks to characterize the peroxide-induced oxidation products of triclosan, such as those which may be produced when personal care products containing triclosan, (e.g. toothpaste) and hydrogen peroxide (e.g. mouth washes and teeth whitening products) are combined. These oxidation products will likely form in water treatment processes in which hydrogen peroxide is used as well. Selected pH values will be investigated to determine if there is a dependence on pH and the formation of the observed oxidation products.

Environmental Effects of Triclosan Exposure

Triclosan is generally recognized as safe for use in human products, however it can present adverse environmental effects. Triclosan is among the most persistent organic pollutants in surface waters⁷¹. Thus the environmental impact of triclosan and its degradation products should not be understated.

Triclosan is a broad spectrum antimicrobial, not being specific to particular bacterial strains. The killing potential of triclosan is dependent on the bacterial strain and how it is equipped to remove triclosan from its cells. Some bacterial strains are capable of surviving triclosan exposure through rapid elimination after the compound has been ingested while other bacteria are highly susceptible and treatment results in cell death^{189,196}.

The prevalence of triclosan in the environment and its use as an antimicrobial has led to concerns about bacterial strains becoming resistant to triclosan. Triclosan-resistant bacteria have been isolated from soils¹⁹³. Triclosan-resistant bacterial strains have also been isolated from natural waterways indicating that exposure to triclosan has an impact on native bacteria. The presence of triclosan may allow for the selection of particular bacterial and algae strains to be present in the environment. This could have impacts up the food chain within the aquatic ecosystem¹⁹⁷. Triclosan resistance is observed in some bacterial strains, but it is still an effective antimicrobial as it is still effective on many other bacterial strains, such as those present in the human mouth¹⁹⁸. The debate surrounding bacterial resistance to triclosan will continue as the literature provides examples across the spectrum from complete resistance to non-resistance¹⁸⁹.

Disposition of Triclosan during Water Treatment

Water treatment processes are capable of removing up to 95% of the triclosan present in incoming water, but what remains may enter the environment from effluent release. However, the decomposition products formed during the treatment process are potentially toxic not only to humans but also to the environment¹². The degradation of

triclosan in the environment may form some of the same oxidation products formed during the water treatment process. Biological degradation of triclosan in aerobic environments of activated sludge treatment of waste water has been demonstrated to form 2,4-dichlorophenol, 4-chlorocatechol, 5-hydroxy-triclosan, as well as other mono- and di- hydroxy-triclosan derivatives. Triclosan-O-sulfate was also detected. These products were hypothesized to form either through simple bond cleavage leading to the formation of phenols and catechols, addition of hydroxyl moieties to the aromatic ring structure, and the attachment of methyl and sulfate groups directly to the oxygen atoms of triclosan and hydroxyl-triclosan derivatives¹⁹⁹.

Triclosan in terrestrial environments comes from the application of sewage sludge on farm lands or leaching of water already contaminated with triclosan. Ying et al.²⁰⁰ investigated the biological degradation of triclosan in soil under aerobic and anaerobic conditions. While no degradation products were identified, the environmental half-life of triclosan during aerobic degradation conditions was determined to be about 18 days and appeared to persist under anaerobic conditions in laboratory studies.

Wastewaters are treated and processed many different ways. Consequently, the variety of degradation products which may form greatly increase from one treatment plant to another. Each treatment method deserves its own study to determine what products are formed. The treatment of wastewater using activated sludge was discussed above, and it presents only one step in the treatment process. In drinking water systems, triclosan reacts with free chlorine yielding a number of potentially toxic

oxidation products. 2,4-Dichlorophenol and chloroform, known carcinogens^{56,111}, were detected in water treated with chlorine¹¹². If excess chlorine is available, it can react further with 2,4-dichlorophenol via electrophilic substitution leading to the formation of 2,4,6-trichlorophenol, which has been shown to be cytotoxic²⁰¹. Also observed were 5,6-dichloro-2-(2,4-dichlorophenoxy)phenol, 4,5-dichloro-2-(2,4-dichlorophenoxy)phenol, and 4,5,6-trichloro-(2,4-dichlorophenoxy)phenol¹¹². The toxicities of these formed compounds are not be known, but it could be concluded that these observed compounds may be toxic as they have structural similarities to 2,4-dichlorophenol. The presence of the carbon-chlorine bonds suggests toxicity as many compounds which have carbon-chlorine bonds present a greater degree of toxicity.

Ozonation has replaced chlorination in many wastewater treatment facilities. Ozone-induced degradation products of triclosan include 2,4-dichlorophenol, which is formed through cleavage of the ether bond. Mono- and di-hydroxy triclosan, 4-chlororesorcinol, and 4-chlorocatechol were also products of triclosan contaminated water treated with ozonation. Of these products, only the toxicity of 2,4-dichlorophenol has been assessed and is classified as harmful to aquatic species and may cause adverse effects to the aquatic environment²⁰².

Fenton chemistry and Fenton-like reactions have been used as oxidative processes for the treatment of wastewater for the removal of organic pollutants²⁰³. Fenton chemistry, or the Fenton reaction, involves the oxidation of organic substances by hydrogen peroxide through its degradation to hydroxide using an iron (II) catalyst (Scheme 8)²⁰⁴. Fenton chemistry is carried out under acidic conditions to prevent the

iron from precipitating out of solution as well as to reduce the evolution of O₂ and increase the evolution of hydroxyl radicals²⁰⁵. In applications of Fenton chemistry to water treatment, the pH is maintained around a value of three^{203,206}. Fenton chemistry has been carried out using electrochemical methods (electro-Fenton) and photochemical methods (photo-Fenton) for additional applications of Fenton chemistry to the water treatment process and more complete oxidation of organic pollutants^{203,205}.

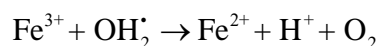
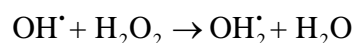
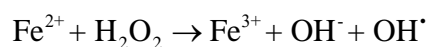

Scheme 8: The generation of hydroxyl radicals from hydrogen peroxide in the Fenton reaction.

Fenton-like reactions involve the cleavage of the oxygen-oxygen bond in hydrogen peroxide and the generation of hydroxyl radicals for the oxidation of organic material like the standard Fenton reaction. However, Fenton-like reactions involve modifications of the standard Fenton chemistry, such as using iron (III) (SCHEME 9) as opposed to iron (II) or use a different metal, such as copper²⁰⁷. The mechanism of hydroxyl radical generation is different based on the metal ion catalyst. Modifications to standard Fenton chemistry are sometimes desirable to insure that the metal ion remains soluble particularly when a basic pH is necessary to generate oxidative species. Iron (III) is quantitatively precipitated as the hydroxide at a low reaction pH. A catalyst capable of activating the formation of hydroxyl radical at neutral pH is desirable for a

water treatment system to minimize the equipment and time necessary for complete and efficient removal of organic pollutants^{207,208}.

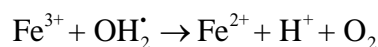
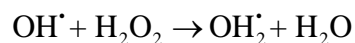
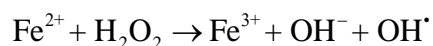
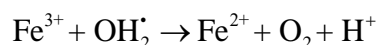
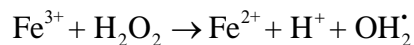

Scheme 9: The generation of hydroxyl radicals from hydrogen peroxide in the Fenton-like reaction using Fe^{3+} .

The products of triclosan oxidation using various different Fenton-like processes have been summarized in Table 4. The formation of 2,4-dichlorophenol was observed as in other studies of triclosan degradation. Other oxidation products observed were 4-chlorocatechol, phenol, hydroquinone, p-benzoquinone, and maleic, acetic, oxalic, and formic acids. The p-hydroquinone of triclosan and p-quinone of triclosan as well as the diols 4,6-dichloro-1,2-benzenediol and 4,6-dichloro-1,3-benzenediol have also been observed^{116,209}. Pond water samples exposed to varying concentrations of phenol have shown a decrease in dissolved oxygen and population of phytoplankton with an increase in phenol concentration. Phenols have been demonstrated to adversely affect fish leading to respiratory distress. Other changes in fish were assumed to be the result of phenols interfering with various enzyme activities²¹⁰. It is possible that other observed oxidation products may be toxic though not yet assessed.

Triclosan is also susceptible to photolysis. Earlier studies of triclosan degradation in the presence of titanium dioxide (TiO_2) catalyst produced different, unidentified dichlorophenol isomers¹¹⁴. It is possible that some of these reaction products may be

responsible for human or ecosystem toxicity. Studies using buffered and natural waters demonstrate that triclosan undergoes photolysis leading to the formation of 2,4-dichlorophenol and 2,8-dichlorodibenzo-p-dioxin. The photolytic formation of the dioxin occurs not only under laboratory lamp sources but also under natural sunlight. The formation of the dioxin also occurs across a broad pH range (4-11.5)^{113,211}. The dioxin was only formed in low yields (up to 12%). However, the dioxin was not detected when solutions of triclosan were treated with TiO₂, hydrogen peroxide, and UV light. Under this method of photocatalytic oxidation, the products formed were 2,4-dichlorophenol, the quinone of triclosan, and the hydroquinone of triclosan²¹². The formation of 2,8-dichlorodibenzo-p-dioxin, though, does not appear to have any toxicological implications. Animal studies have indicated that there are no toxicological effects after exposure to 2,8-dichlorodibenzo-p-dioxin^{213,214}. In fact, studies using goldfish indicated a very rapid metabolism and elimination which likely minimized the potential for toxic effects. Other dibenzo-p-dioxins do demonstrate toxicity in aquatic species, such as fathead minnows and rainbow trout²¹⁵. Table 4 is a summary of different degradation strategies and the products each of these methods produces.

Table 4. Summary of triclosan oxidation products by treatment or reaction conditions.

Oxidation Products	Biological Degradation	Chlorination	Ozonation	Fenton and Fenton-like Reactions	Photolysis	References
2,4,6- trichlorophenol		x				112
2,4-dichlorophenol	x	x	x	x	x	112, 113, 116, 197, 200, 207, 209, 210
2,8-dichlorodibenzo-p-dioxin					x	113, 209
4,5,6-trichloro-(2,4-dichlorophenoxy)phenol		x				112
4,5-dichloro-2-(2,4-dichlorophenoxy)phenol		x				112
4,6-dichloro-1,2-benzenediol				x		116, 207
4,6-dichloro-1,3-benzenediol				x		116, 207
4-chlorocatechol	x		x	x		116, 197, 200, 207
4-chlororesorcinol			x			200
5,6-dichloro-2-(2,4-dichlorophenoxy)phenol		x				112
5-hydroxy-triclosan	x					197
Acetic acid				x		116, 207
Chloroform		x				112
Mono- and di-hydroxy-triclosan and derivatives	x		x			197, 200
Formic acid				x		116, 207
Hydroquinone				x		116, 207
Maleic acid				x		116, 207
Oxalic acid				x		116, 207
Benzoquinones of triclosan				x	x	116, 207, 210
Phenol				x		116, 207
Hydroquinone of triclosan				x	x	116, 207, 210
Triclosan-O-sulfate	x					197

Preliminary Reaction Screening

Fenton-like reactions were carried out by reacting triclosan, hydrogen peroxide and sodium hydroxide at different pH values. Reactions mixtures were screened by direct infusion into an ion trap MS operated in full scan mode to verify that the reaction

occurred. The reaction mixtures indicated the presence of a dichlorophenol. Analysis of the same samples using LC-TOFMS indicated that what was observed via direct infusion of a sample reacted at approximately pH 10 using 12% hydrogen peroxide on the ion trap MS was a set of three isomers proposed to be different dichlorophenol isomers (Figure 43). The isotope ratios of the m/z 160.9, m/z 162.9, and m/z 164.9 ions, as observed in the mass spectrum, are consistent with the $(M-H)^-$ ions formed by dichlorophenols (Figure 44). The observed masses compare favorably to the theoretical masses (160.9566/162.9537/164.9507 Daltons). The mass errors of the peak eluting at 21 minutes are 0, 1.3, and 1.3 ppm. The second peak eluting at 22 minutes had mass errors of 2.5, 2.5 and 1.3 ppm. Mass errors of 2.5, 1.9, and 17.6 ppm were associated with the peak eluting at 24 minutes. The formation of 2,4-dichlorophenol from the oxidation of triclosan is known. However, the formation of other dichlorophenols from triclosan, while proposed, has not been observed in the environment or water treatment process¹¹². It is hypothesized that the non-specific addition of a hydroxyl radical under basic conditions on a benzene ring may lead to the formation of the three hypothesized isomeric dichlorophenols. In addition to the formation of 2,4-dichlorophenol, it is thought that 3,5- and 2,6-dichlorophenol are the dichlorophenols most likely to be formed from oxidation of triclosan using hydrogen peroxide under basic conditions (Scheme 10).

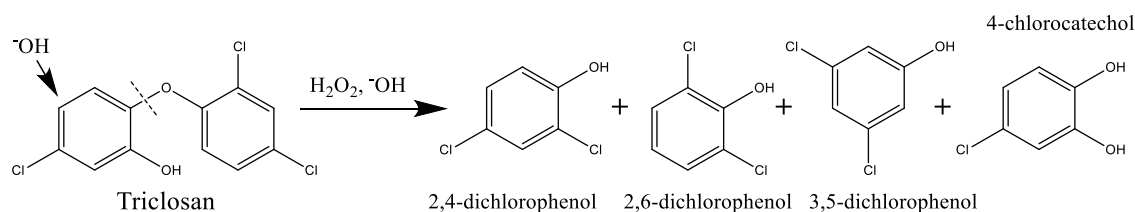

Scheme 10. Proposed formation of three isomeric dichlorophenols from the reaction of triclosan with hydrogen peroxide at a pH of approximately 10.

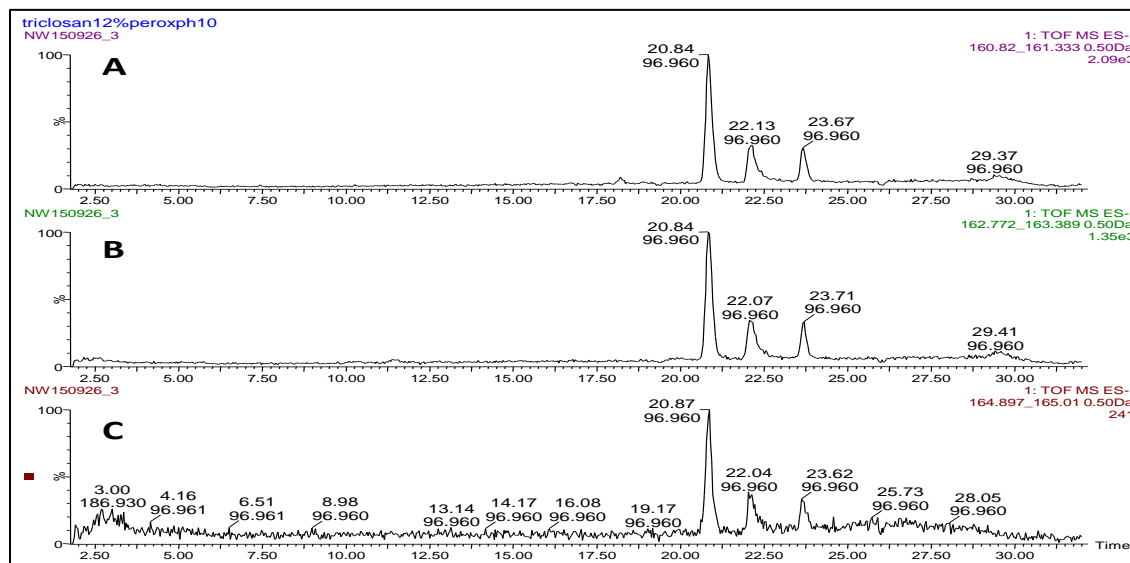

Figure 43. LC-TOFMS extracted ion chromatograms of the (A) m/z 160.9 ion, (B) m/z 162.9 ion, and (C) m/z 164.9 ion.

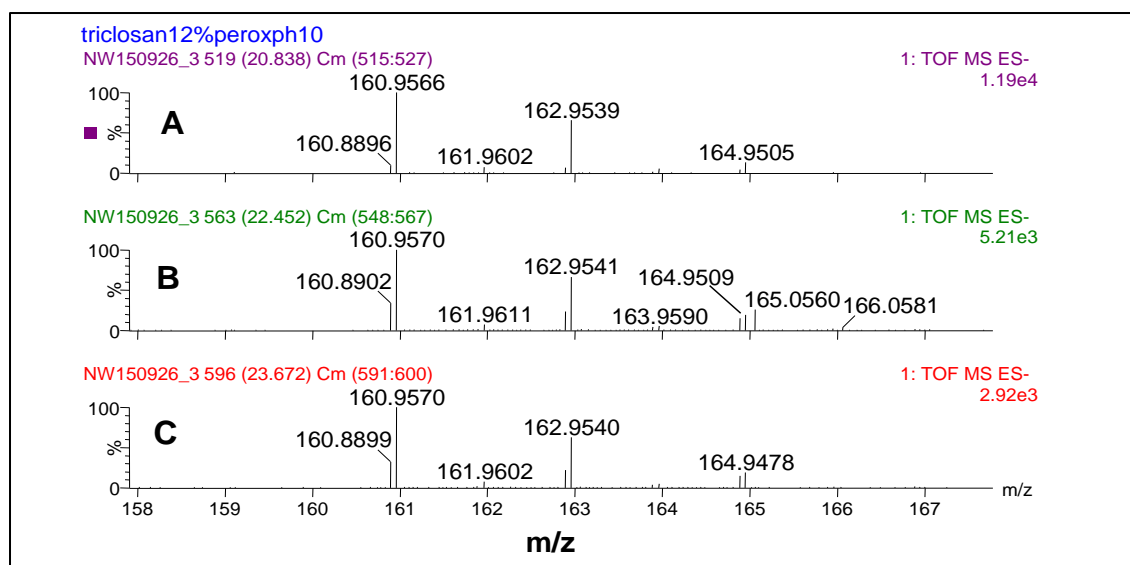

Figure 44. Negative ion LC-TOFMS spectra of the dichlorophenols eluting at (A) 21 minutes, (B) 22 minutes, and (C) 24 minutes.

Identification of the Unknown Oxidation Products

Triclosan oxidation reactions were carried out for the purpose of identifying dichlorophenols and other reaction products formed under oxidative conditions at different pH values. The conventional Fenton reaction uses Fe^{2+} as a catalyst and is performed under acidic conditions to maintain the iron in solution. Previous studies have used Fe^{3+} as the iron source with acidic reaction conditions¹¹⁶. Electro-Fenton reactions have been studied but these have used Fe^{2+} as the catalyst similar to the traditional Fenton reaction²⁰⁹. The presented work does not rely on a metal catalyst, but there is still a reliance on the generation of the hydroxyl radical from the decomposition of hydrogen peroxide. A pH range is also investigated to determine the effects of pH on the formation of the oxidation products, specifically dichlorophenols. This reaction is classified as a Fenton-like reaction.

A triple quadrupole mass spectrometer (Agilent 6460) was used to analyze the reaction mixtures. Product ion mass spectra of different reaction products were acquired to help determine their structures. Dichlorophenol reaction products were identified. The analysis provided a positive result of three peaks for the m/z 161 ion (the $(\text{M}-\text{H})^-$ indicative of the deprotonated dichlorophenol ion having only the ^{35}Cl isotope) (Figure 45). Product ion spectra were collected for both the m/z 161 and m/z 163 ions (see Figure 46 for example) to help differentiate structures. The product ion spectra show a sequential neutral loss of HCl and no additional fragmentation. The lack of additional fragmentation indicates the presence of a ring structure. The mass remaining after the sequential loss of HCl indicates the presence of a benzene-like ring structure.

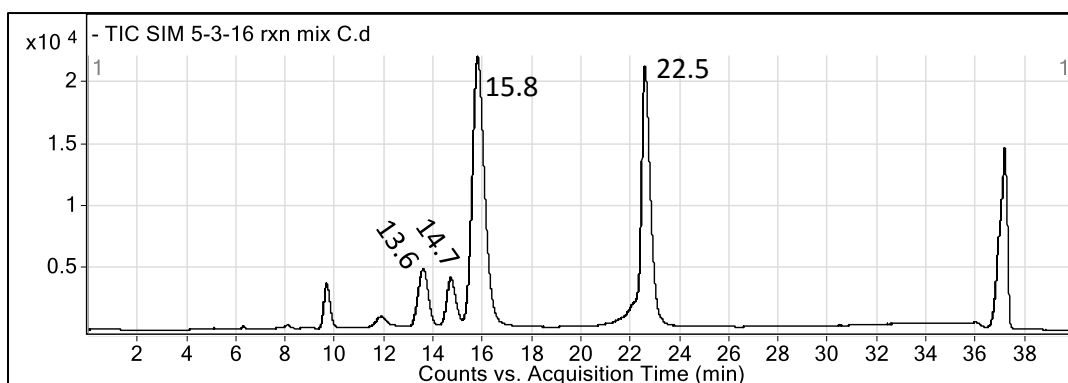

Figure 45. LC/MS/MS extracted ion chromatogram for m/z 161 from a reaction preformed at a pH of approximately 10.

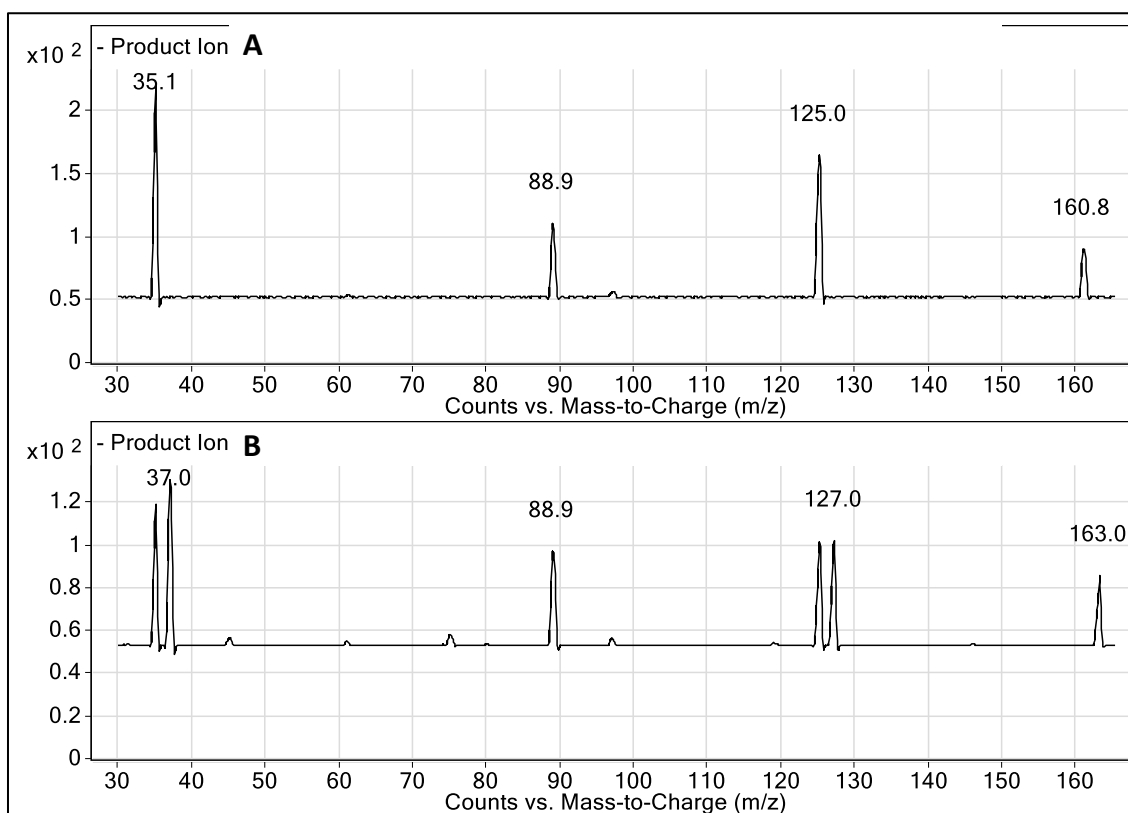

Figure 46. Product ion spectra of the (A) m/z 161 and (B) m/z 163 molecular ions for the unknown eluting at 15.8 minutes.

The product ion spectra of the six known dichlorophenols were obtained (Figures 47-52). There are no differences between the product ion spectra of the six standards other than differences in peak intensities. The product ion spectra of the unknowns

were consistent with those of the dichlorophenol standards. The conclusion that the three unknowns are dichlorophenols is thus plausible.

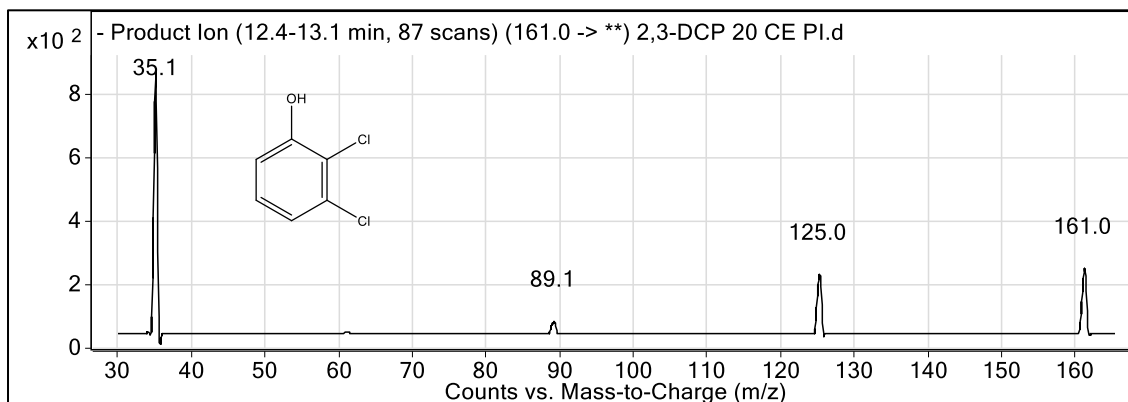

Figure 47. The structure of 2,3-dichlorophenol and its product ion spectrum of m/z 161 (the (M-H)⁻ ion having a formula of $^{12}\text{C}_6\text{H}_3^{35}\text{Cl}_2\text{O}$).

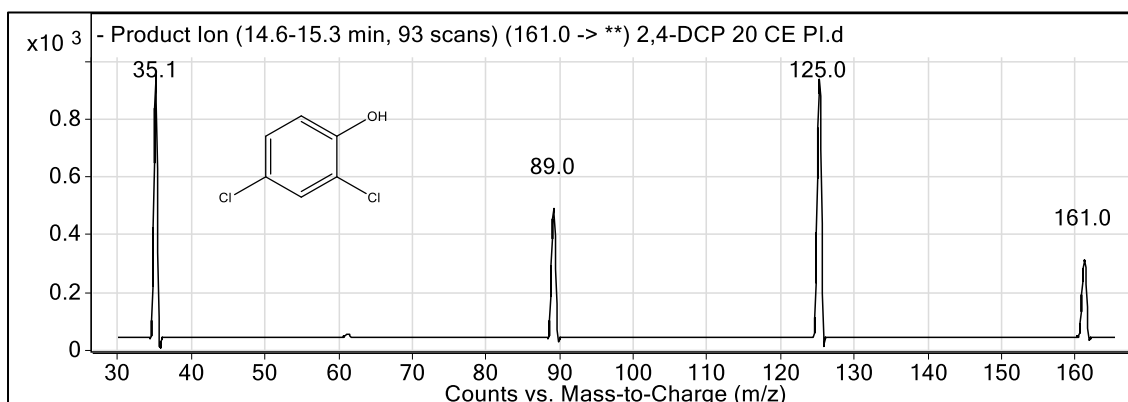

Figure 48. The structure of 2,4-dichlorophenol and its product ion spectrum of m/z 161 (the (M-H)⁻ ion having a formula of $^{12}\text{C}_6\text{H}_3^{35}\text{Cl}_2\text{O}$).

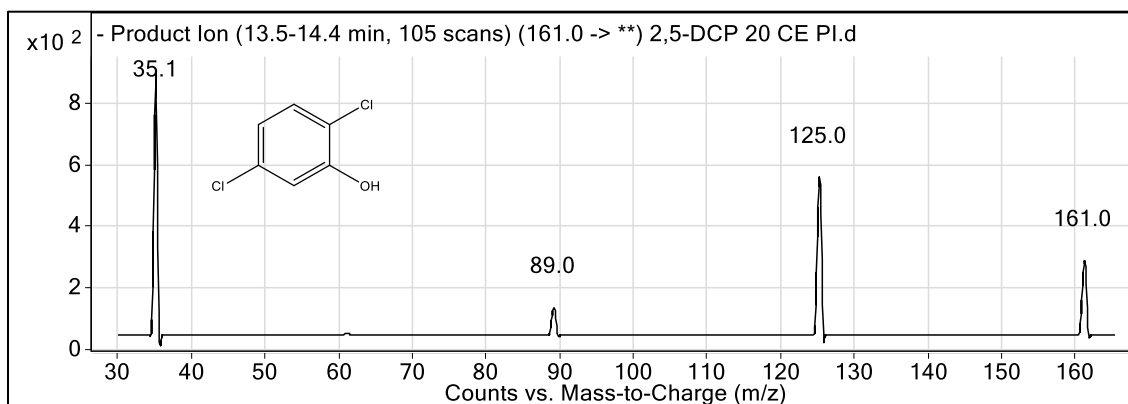

Figure 49. The structure of 2,5-dichlorophenol and its product ion spectrum of m/z 161 (the (M-H)⁻ ion having a formula of $^{12}\text{C}_6\text{H}_3^{35}\text{Cl}_2\text{O}$).

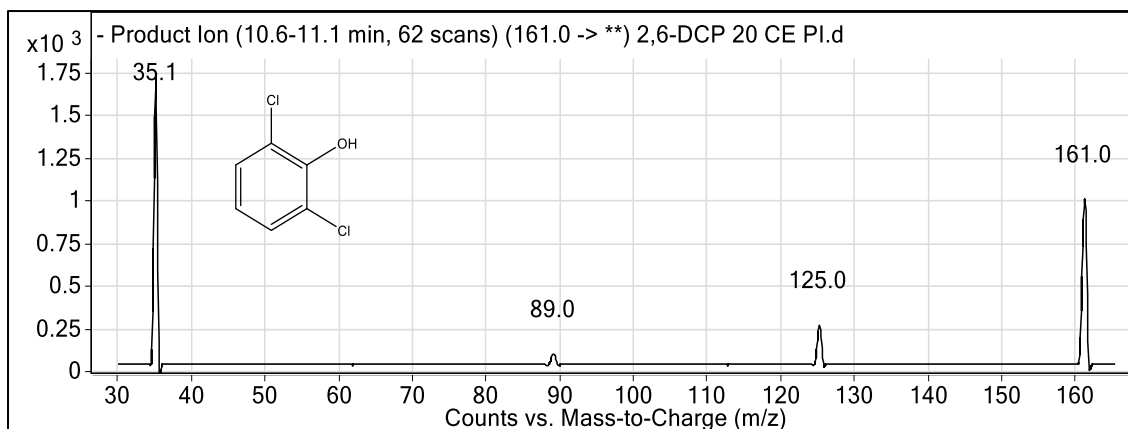

Figure 50. The structure of 2,6-dichlorophenol and its product ion spectrum of m/z 161 (the $(M-H)^-$ ion having a formula of $^{12}C_6H_3^{35}Cl_2O$).

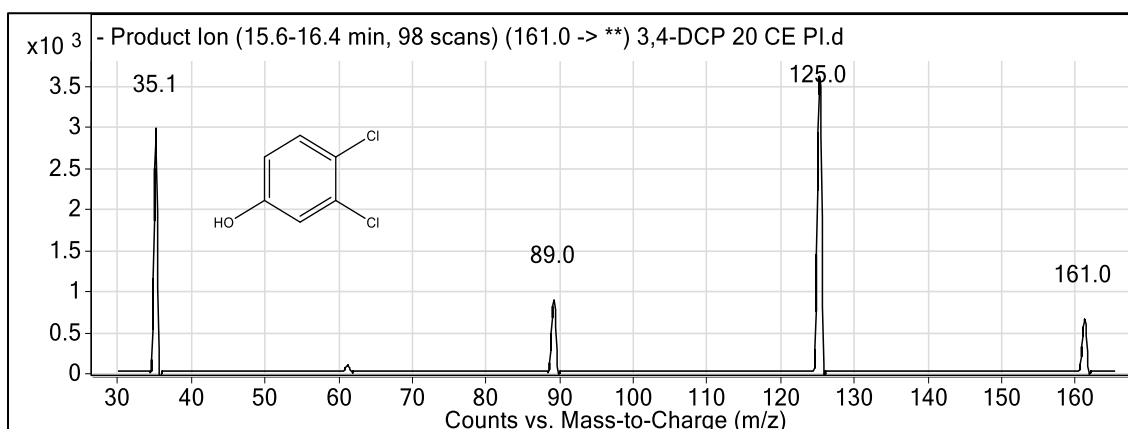

Figure 51. The structure of 3,4-dichlorophenol and its product ion spectrum of m/z 161 (the $(M-H)^-$ ion having a formula of $^{12}C_6H_3^{35}Cl_2O$).

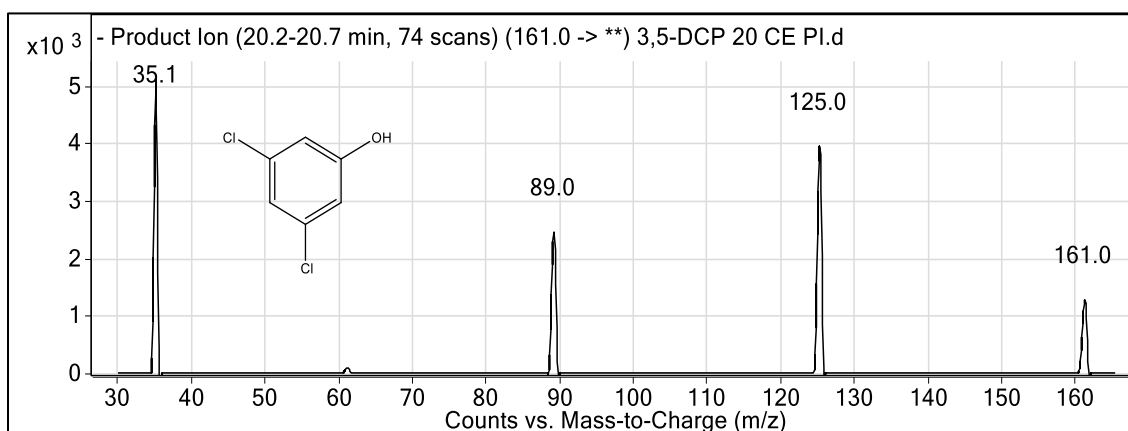

Figure 52. The structure of 3,5-dichlorophenol and its product ion spectrum of m/z 161 (the $(M-H)^-$ ion having a formula of $^{12}C_6H_3^{35}Cl_2O$).

The retention times of the six dichlorophenols were compared to those of the reaction products suggested to be dichlorophenols. Retention times from the standard solution indicated that the unknowns were likely 2,4-, 2,5-, and 3,4-dichlorophenol. These standards were spiked into the reaction mixture and analyzed using SIM (Figure 53). No new peaks were observed, and the three peak areas which were believed to be these three dichlorophenols greatly increased. The standards were spiked into the reaction mixture for analysis rather than attempting cochromatography as the width of the chromatographic peaks at the base were equivalent to the differences in the retention times associated with the standards. Retention times were later verified using LC-TOFMS as discussed below. The above observed masses from HRMS analysis also fit to within 4 ppm mass error of the predicted masses of the dichlorophenols. It can be concluded that, at a pH of approximately 10, the oxidation of triclosan using hydrogen peroxide results in the formation of 2,4-dichlorophenol (14.7 minutes), 2,5-dichlorophenol (13.6 minutes), and 3,4-dichlorophenol (15.8 minutes).

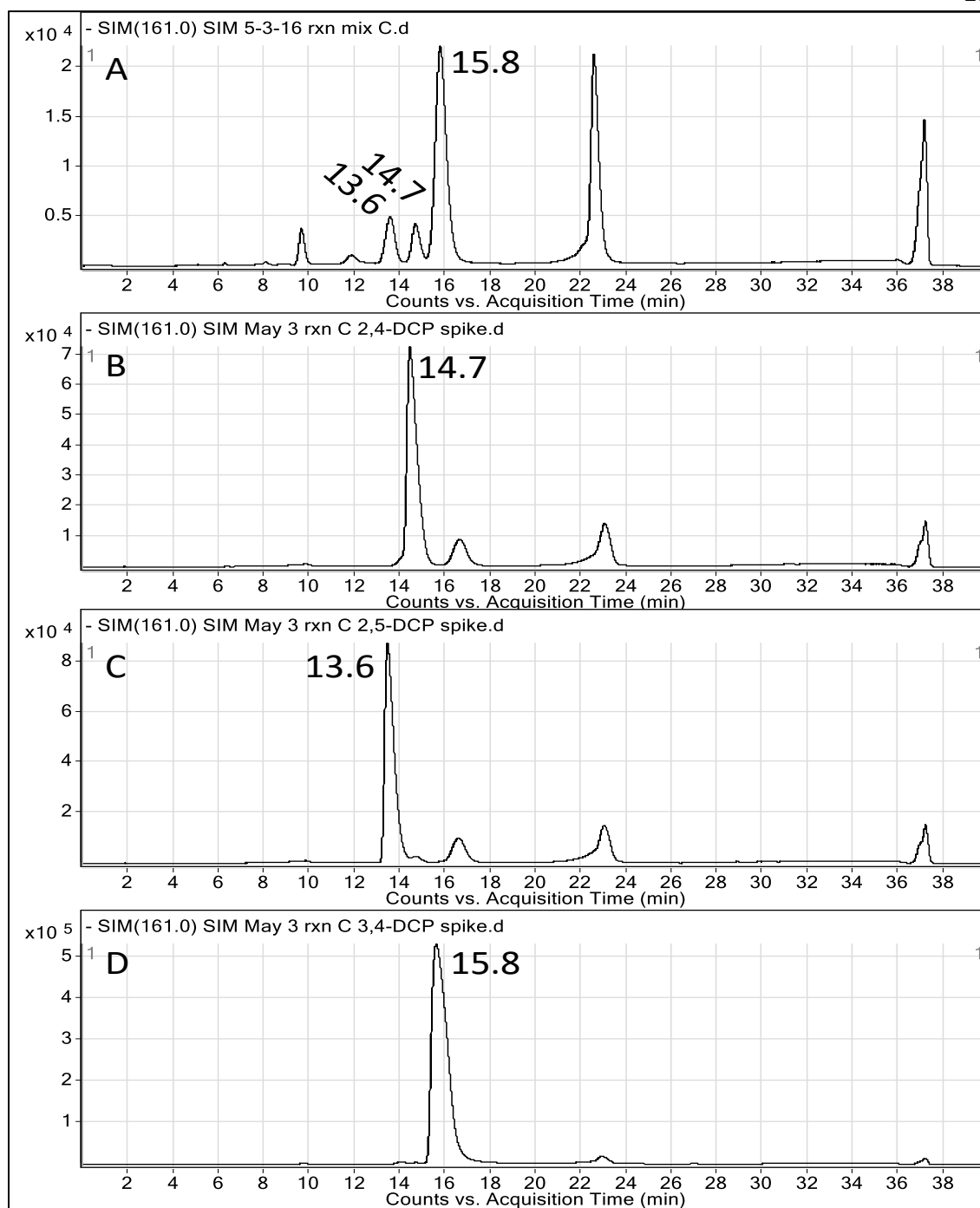
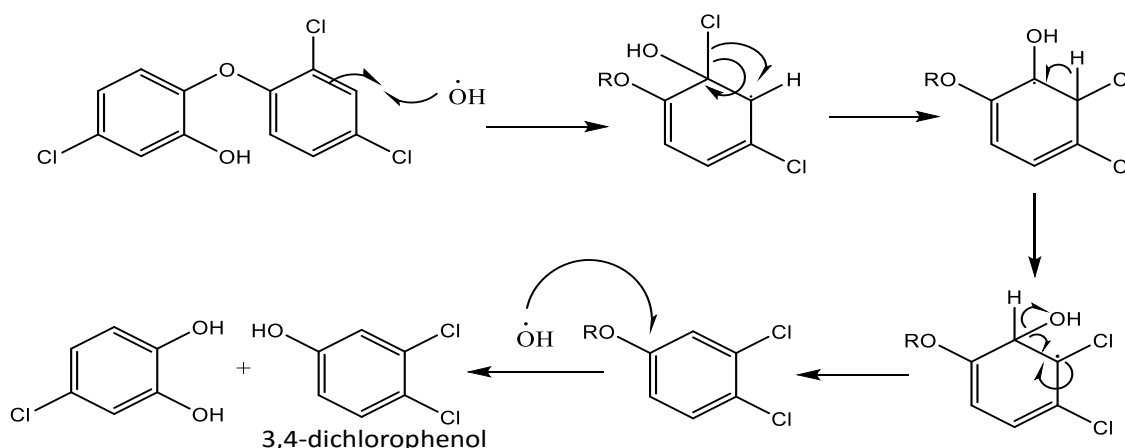
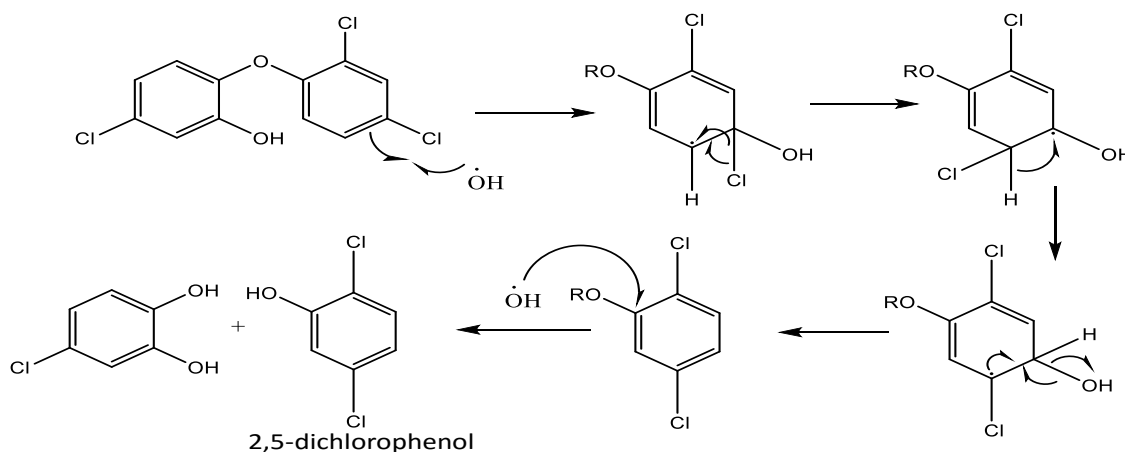

Figure 53. Extracted ion chromatograms of m/z 161 from a pH 10 reaction (A) not spiked, and spiked with (B) 2,4-dichlorophenol, (C) 2,5-dichlorophenol, and (D) 3,4-dichlorophenol.

The proposed mechanism of triclosan oxidation leading to 1,3-dichlorophenols, which is how 2,4-dichlorophenol is formed, is inconsistent for the reaction products of 2,5-dichlorophenol and 3,4-dichlorophenol. It is hypothesized that the formation of the 2,5- and 3,4-dichlorophenols proceeds through a multistep process involving attack by two separate hydroxyl radicals (Schemes 11 and 12). While the location of hydroxyl radical differs in the initial step of each mechanism, the final attack is always at the same position leading to the cleavage of the ether linkage.



Scheme 11. The proposed mechanism of triclosan oxidation leading to the formation of 3,4-dichlorophenol.



Scheme 12. The proposed mechanism of triclosan oxidation leading to the formation of 2,5-dichlorophenol.

The peak observed at a retention time of 22.5 minutes in Figure 45 does not coelute with any of the six isomeric dichlorophenol standards. The isotope pattern of the molecular ion is consistent with that of a dichlorinated compound (Figure 54). However, none of the retention times of the six dichlorophenol standards match. The product ion spectrum is also similar to those of the dichlorophenols (Figure 55), specifically 3,5-dichlorophenol.

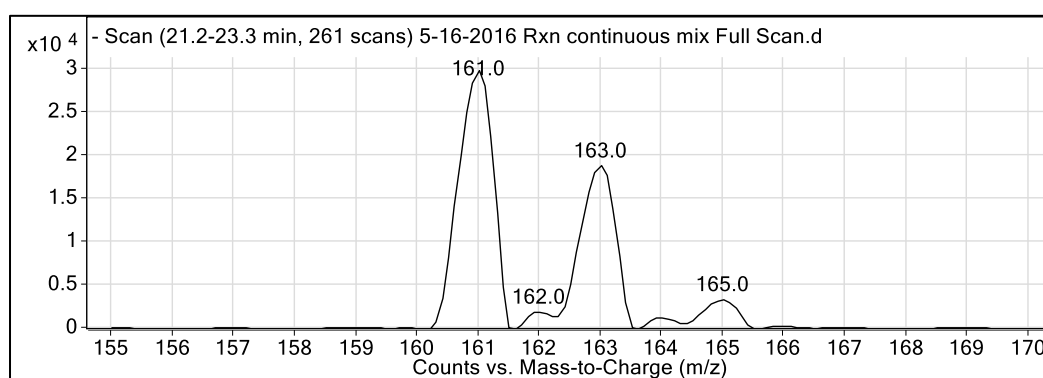

Figure 54. Full scan spectrum of the unknown peak centered at 22.5 minutes show a dichlorinated compound (isotope ratio of about 100:64:10).

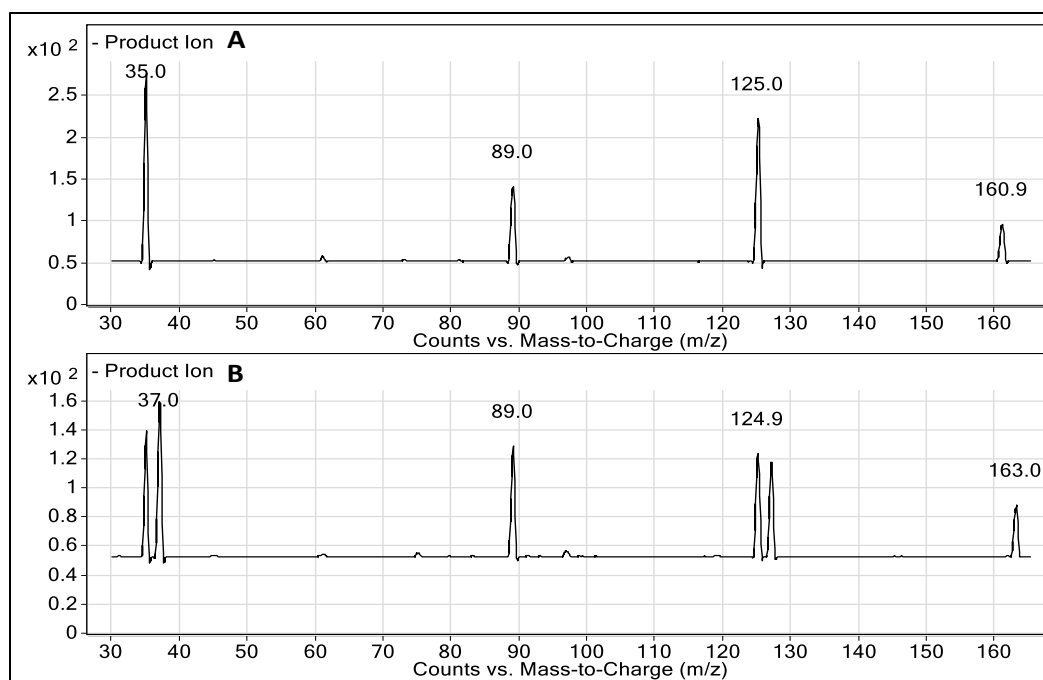

Figure 55. Product ion spectra of the late eluting peak for (A) m/z 161 and (B) m/z 163.

The evidence from mass spectrometry indicates that the structure of the unknown is similar to that of the dichlorophenols. It is hypothesized that this unknown is a semi-quinone with two chlorine atoms or some other similar structure. The ionization of this compound under ESI conditions is proposed to proceed through a mechanism similar to that proposed for quinones (Figure 56)⁴⁸. Here the semi-quinone would form the same ion structure as a dichlorophenol

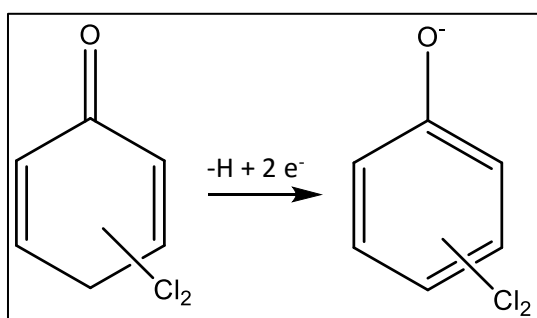

Figure 56. A proposed mechanism for ionization of the hypothesized semi-quinone structure (reactant) using ESI.

Effects of pH on Product Formation

The effect of pH on Fenton and Fenton-like reactions has been well documented. The effects of pH were investigated with the oxidation of triclosan using hydrogen peroxide in a Fenton-like reaction over the pH range of three to ten.

A mixture of all six dichlorophenols was analyzed to ensure resolution between eluting compounds (Figure 57). Resolution was achieved, but it was noted that 3,4- and 3,5-dichlorophenol ionized more efficiently than any of the other isomers and formed particularly broad peaks. Those peaks for the remaining four dichlorophenols with retention times between 10.2 and 15.4 minutes are shown in the inset of Figure 57.

However, resolution between 2,4- and 3,4-dichlorophenol was maintained at the concentration analyzed.

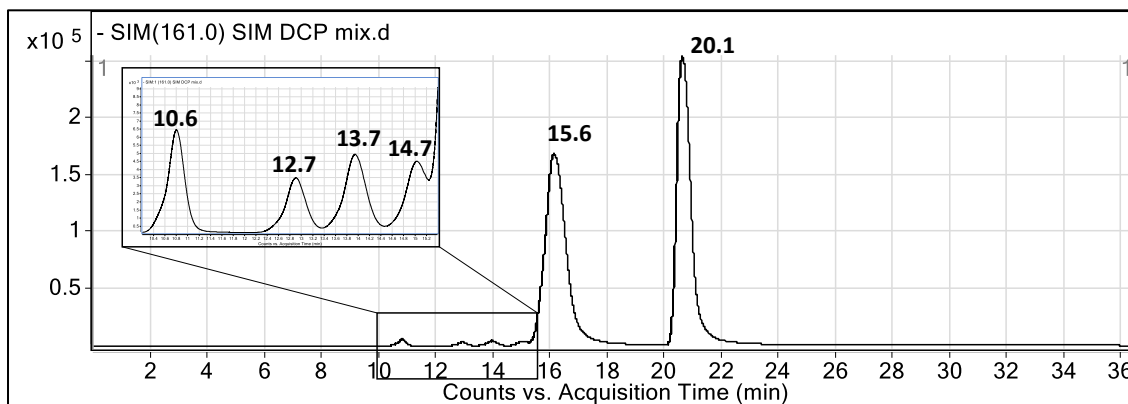

Figure 57. Extracted ion chromatogram of m/z 161 from a mixture of the six dichlorophenol standards each at a concentration of $167 \mu\text{g/mL}$.

The unknown compound eluting at 22.5 ± 0.2 minutes was consistently present across the tested pH range (Figures 58-65). 2,4-Dichlorophenol (retention time of 14.8 ± 0.1 minutes) was observed forming in samples having been reacted at approximately a pH of 5, 9, and 10 (Figures 60, 64, and 65). 3,4-Dichlorophenol (retention time of 15.7 ± 0.3 minutes) was observed forming in samples having been reacted at approximately a pH of 3, 4, 6, 7, 8, and 10 (Figures 58, 59, 61-63, and 65). The presence of 2,5-dichlorophenol (retention time of 13.3 ± 0.1 minutes) was indicated at minimal relative concentrations in samples reacted at a pH of 4, 6, and 7 (Figures 59, 61, and 62) as well as formed at a much higher relative concentration in the pH 10 reaction (Figure 65).

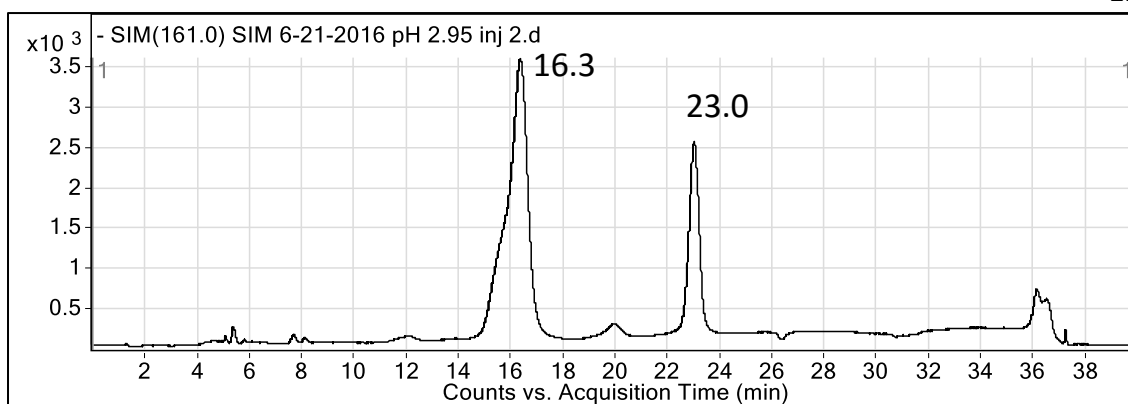

Figure 58. Extracted ion chromatogram of m/z 161 from a reaction performed at a pH of approximately 3.

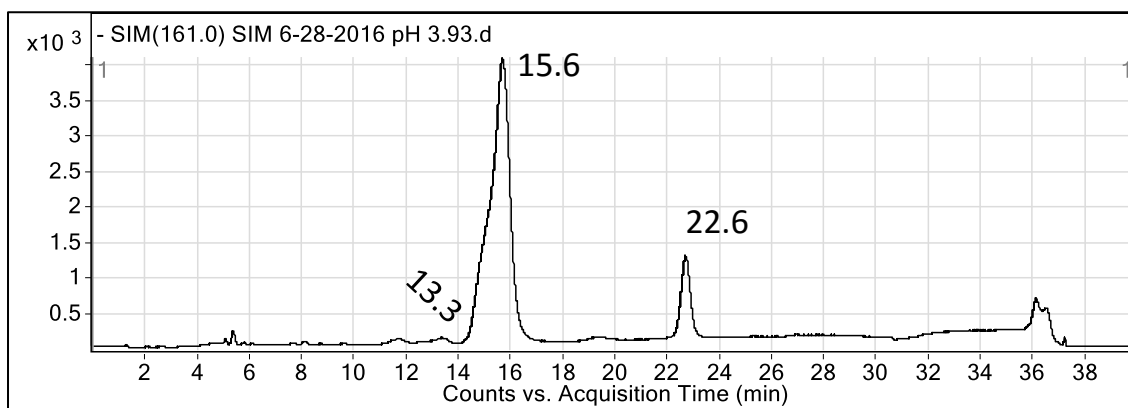

Figure 59. Extracted ion chromatogram of m/z 161 from a reaction performed at a pH of approximately 4.

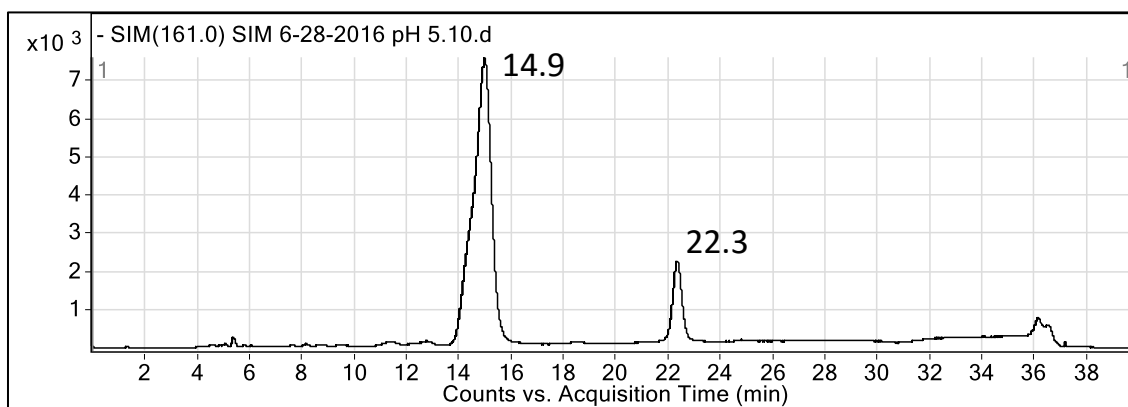

Figure 60. Extracted ion chromatogram of m/z 161 from a reaction performed at a pH of approximately 5.

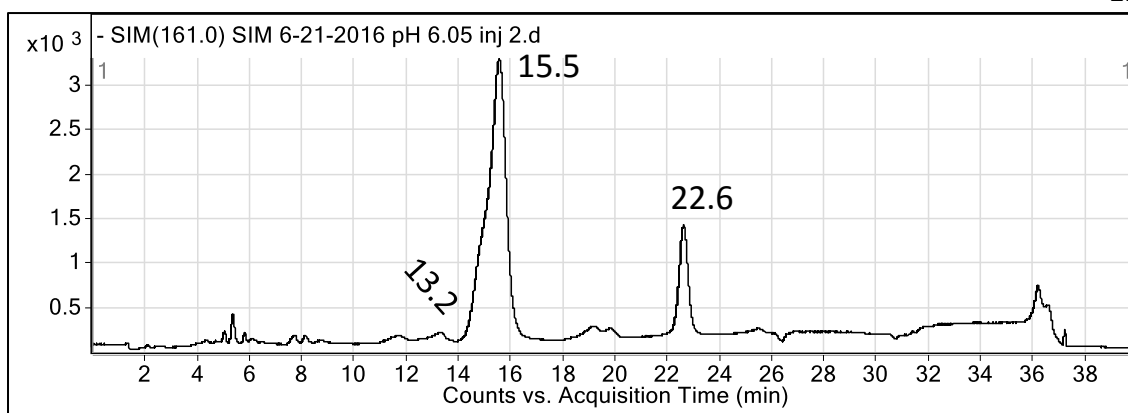

Figure 61. Extracted ion chromatogram of m/z 161 from a reaction performed at a pH of approximately 6.

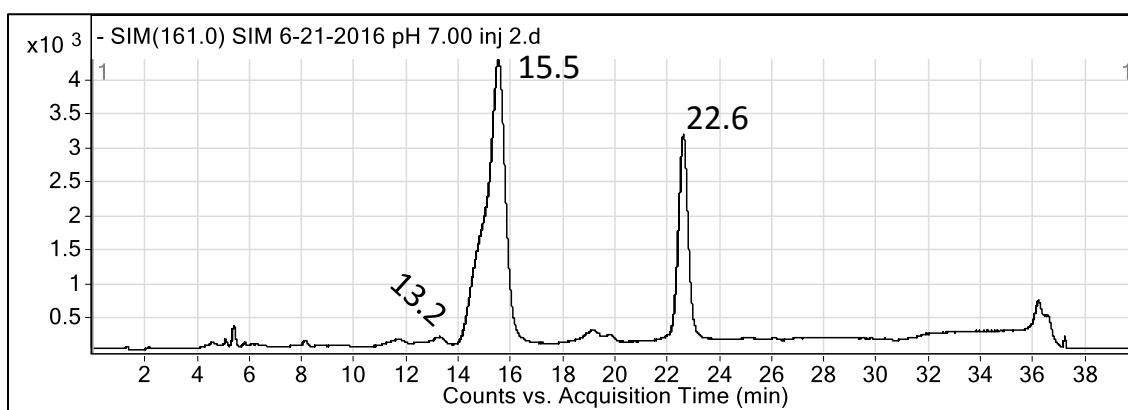

Figure 62. Extracted ion chromatogram of m/z 161 from a reaction performed at a pH of approximately 7.

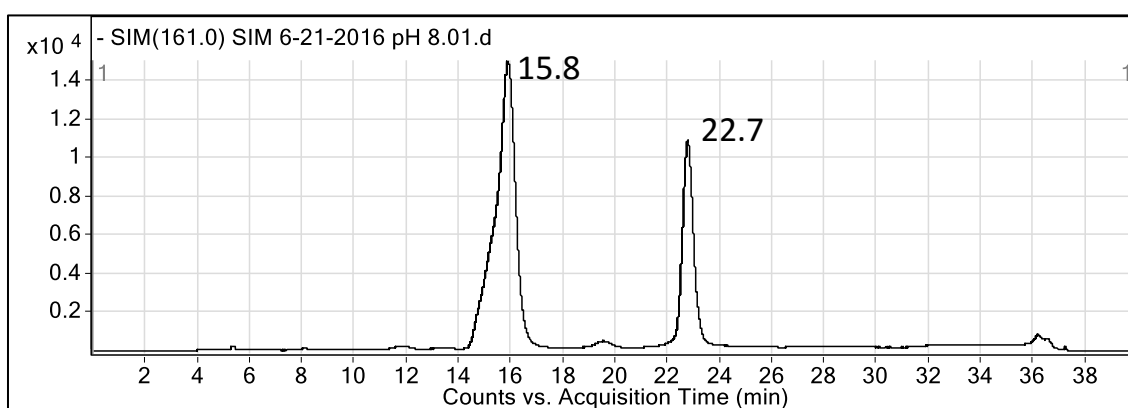

Figure 63. Extracted ion chromatogram of m/z 161 from a reaction performed at a pH of approximately 8.

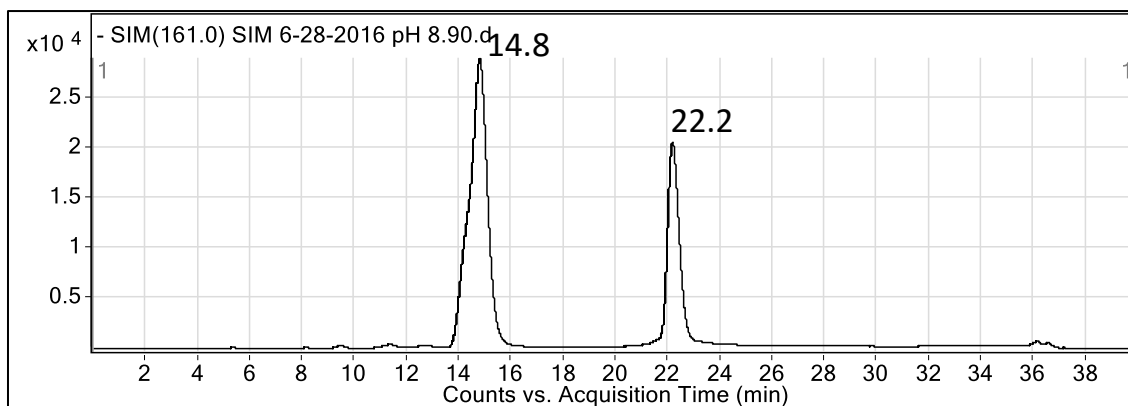

Figure 64. Extracted ion chromatogram of m/z 161 from a reaction performed at a pH of approximately 9.

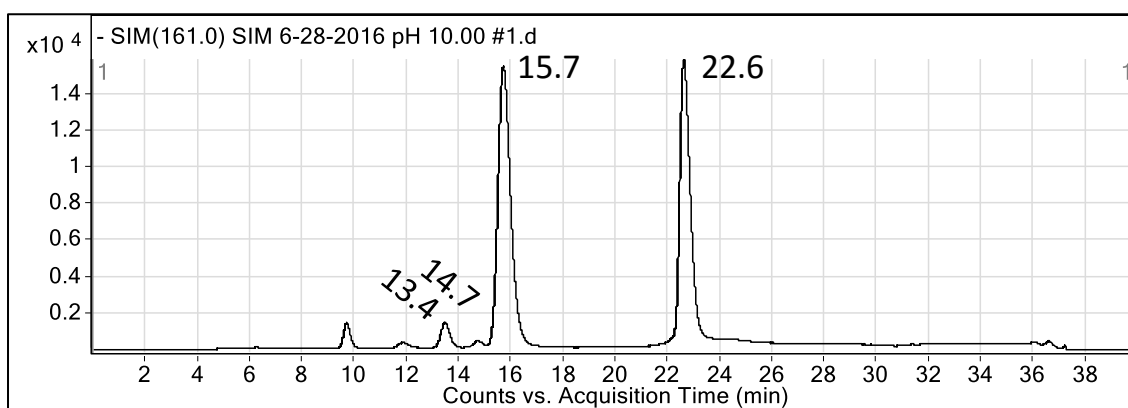

Figure 65. Extracted ion chromatogram of m/z 161 from a reaction performed at a pH of approximately 10.

The identifications of the unknowns run at different pH values were made by matching the closest retention time with that of the standards. It is assumed that, while the peaks may be broad, each given peak is only representative of a single compound as resolution between 2,4- and 3,4-dichlorophenol may not be visible/achievable at high $\mu\text{g}/\text{mL}$ concentrations. The data appears to indicate a trend in the relative concentration of oxidation product based on pH. The formation of 2,4-dichlorophenol appears to reach a maximum concentration at a pH of 9 and then drops significantly at a pH of 10. The relative concentration of 3,4-dichlorophenol appears to reach a maximum concentration

at a pH of 8, and that of the unknown reaches a maximum at a pH of 9. The formation of 2,5-dichlorophenol appears to be only minimal at pH values less than 10 where it achieves a maximum relative concentration (Figure 66). The formation of these compounds from the oxidation of triclosan should be regarded with concern as they are forming at any environmentally and orally relevant pH.

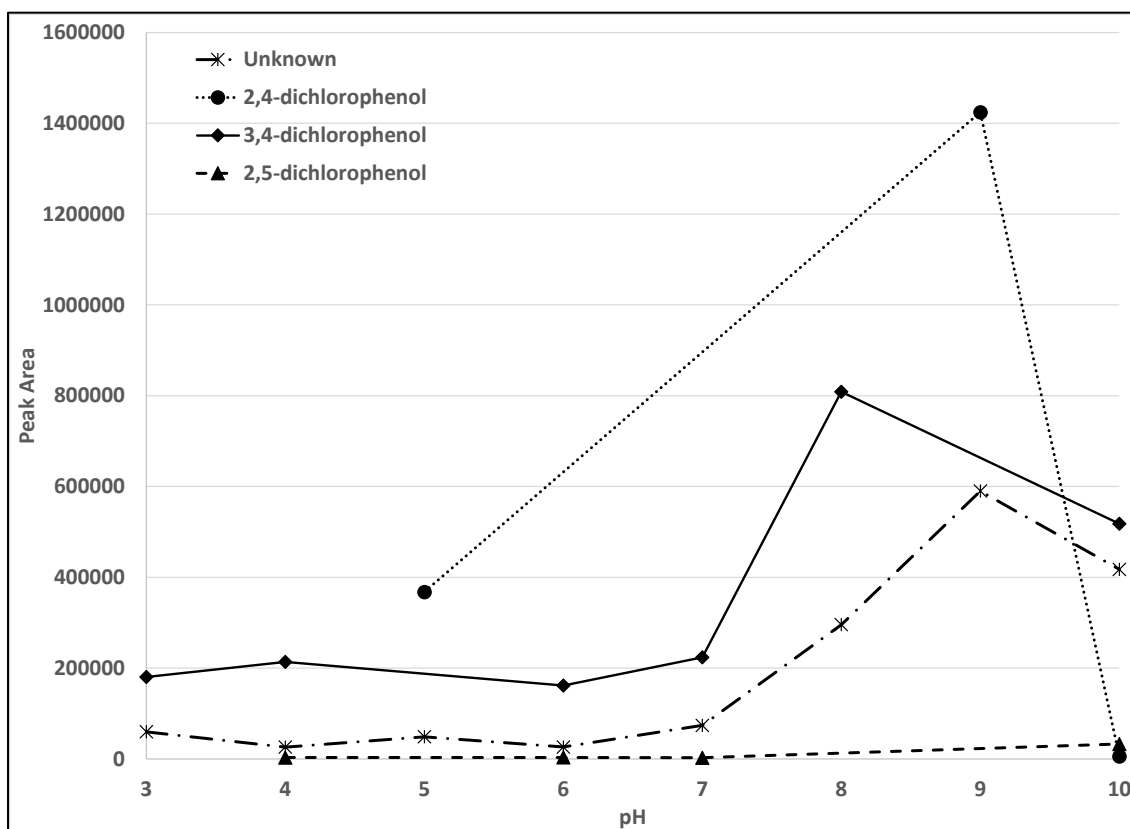

Figure 66. Comparison of the relative concentration (peak area) of 2,4-dichlorophenol, 2,5-dichlorophenol, 3,4-dichlorophenol, and the unknown based on reaction pH.

Conclusion

The oxidation of triclosan under basic conditions using hydrogen peroxide has been demonstrated to lead to the formation of 2,4-dichlorophenol, 2,5-dichlorophenol, and 3,4-dichlorophenol. Only 2,4-dichlorophenol, but not 2,5- and 3,4- dichlorophenols,

has been previously known to form from the degradation of triclosan. The formation of the 2,4-dichlorophenol is formed through the base-mediated cleavage of the ether linkage leading to both the formation of the dichlorophenol and 4-chlorocatechol. The 3,4- and 2,5-dichlorophenols are believed to form through a 1,2 chloride shift through the above proposed mechanisms.

The unidentified late eluting peak is hypothesized to be a semi-quinone with two chlorine atoms attached. The similarities in the product ion spectra of the peak eluting at 22.5 minutes and the dichlorophenols suggest that the ion formed during negative ESI may undergo a reduction to isomerize to a dichlorophenol structure, similar to what was observed in the negative ion ESI of halogenated quinones presumably. The semi-quinone, 3,4-dichlorophenol, and 2,5-dichlorophenol are suggested to be formed by a mechanism that involves at least two hydroxyl radical attacks, the second of which cleaves triclosan at the ether linkage. As observed in the formation of the 2,5- and 3,4-dichlorophenols, the formation of the semi-quinone likely also involves a 1,2-chlorine atom shift.

The formation of the 2,4-, 2,5-, and 3,4-dichlorophenols, as well as the late eluting unknown (at 22.5 minutes) may occur at pH values consistent with those observed in aquatic environments and when oral hygiene products are combined. The formation of these compounds at a neutral pH should be a cause for concern both for human and environmental health given the known toxicity of the dichlorophenols formed.

LIST OF REFERENCES

- (1) The History of Drinking Water Treatment; EPA 816-F-00-006; Office of Water, U.S. Environmental Protection Agency, February 2000.
- (2) Drinking Water Treatment; EPA 810-F-99-013; U.S. Environmental Protection Agency, December 1999.
- (3) 25 Years of the Safe Drinking Water Act: History and Trends; EPA 816-R-99-007; Office of Water, U.S. Environmental Protection Agency, December 1999.
- (4) Drinan, J.E.; Spellman, F.R. *Water and Wastewater Treatment – A Guide for the Nonengineering Professional*, 2nd ed. CRC Press, Taylor & Francis Group: Boca Raton, FL, 2013.
- (5) Metropolitan Water Reclamation District of Greater Chicago Home Page. www.mwrd.org/irj/portal/anonymous/Home (Accessed November 15, 2013).
- (6) Brown, J.L. Landmarks in American Civil Engineering History: Reversal of the Chicago River. *Civil Engineering*. **2002**, 72, 110-111.
- (7) Hansen, B. The Reversal of the Chicago River: Flushing the System. *Civil Engineering*. **2009**, 79, 40-43.
- (8) Chicago River and North Shore Channel Corridors. Illinois Coastal Management Program Issue Paper; Illinois Department of Natural Resources, **2011**.
- (9) Chemical Abstracts Service. www.cas.org (Accessed July 14, 2015).
- (10) Snyder, S.A.; Villeneuve, D.L.; Snyder, E. M.; Giesy, J.P. Identification and Quantification of Estrogen Receptor Agonists in Wastewater Effluents. *Environ. Sci. Technol.* **2001**, 35, 3620-3625.
- (11) Desbrow, C.; Routledge, E.J.; Brighty, G.C.; Sumpter, J.P.; Waldock, M. Identification of Estrogenic Chemicals in STW Effluent. 1. Chemical Fractionation and in Vitro Biological Screening. *Environ. Sci. Technol.* **1998**, 32, 1549-1558.

- (12) Benotti, M.J.; Trenholm, R.A.; Vanderford, B.J.; Holady, J.C.; Stanford, B.D.; Snyder, S.A. Pharmaceuticals and Endocrine Disrupting Compounds in U.S. Drinking Water. *Environ. Sci. Technol.* **2009**, 43, 597-603.
- (13) Hrudey, S.E. Chlorination Disinfection By-Products, Public Health Risk Tradeoffs and Me. *Water Research.* **2009**, 43, 2057-2092.
- (14) Villanueva, C.M.; Cantor, K.P.; Cordier, S.; Jaakkola, J.J.K.; King, W.D.; Lynch, C.F.; Porru, S.; Kogevinas, M. Disinfection Byproducts and Bladder Cancer: A Pooled Analysis. *Epidemiology.* **2004**, 15, 357-367.
- (15) Daughton, C.G.; Ternes, T. A. Pharmaceuticals and Personal Care Products in the Environment: Agents of Subtle Change? *Environ. Health Perspect.* **1999**, 107, 907-938.
- (16) Powick, D.E.J. Swimming Pools – Brief Outline of Water Treatment and Management. *Water Science and Technology.* **1989**, 21, 151-160.
- (17) Wojtowicz, J.A. Water Treatment of Swimming Pools, Spas, and Hot Tubs. *Kirk-Othmer Concise Encyclopedia of Chemical Technology*, 5th Edition. John Wiley & Sons, Inc.: Hoboken, New Jersey, **2007**; Volume 2, pp 1218-1221.
- (18) WWAP (World Water Assessment Programme). The United Nations World Water Development Report 4: Managing Water Under Uncertainty and Risk. Paris, UNESCO. **2012**.
- (19) Bound, J.P.; Voulvoulis, N. Household Disposal of Pharmaceuticals as a Pathway for Aquatic Contamination in the United Kingdom. *Environ. Health Perspect.* **2005**, 113, 1705-1711.
- (20) Daughton, C.G.; Ruhoy, I.S. Environmental Footprint of Pharmaceuticals: The Significance of Factors Beyond Direct Excretion to Sewers. *Environ. Toxicol. Chem.* **2009**, 28, 2495-2521.
- (21) Castiglioni, S.; Zuccato, E.; Crisci, E.; Chiabrando, C.; Fanelli, R.; Bagnati, R. Identification and Measurement of Illicit Drugs and Their Metabolites in Urban Wastewater by Liquid Chromatography-Tandem Mass Spectrometry. *Anal. Chem.* **2006**, 78, 8421-8429.
- (22) Verlicchi, P.; Galletti, A.; Petrovic, M.; Barceló, D. Hospital Effluents as a Source of Emerging Pollutants: An Overview of Micropollutants and Sustainable Treatment Options. *Journal of Hydrology.* **2010**, 389, 416-428.

- (23) Richardson, S.D.; Ternes, T.A. Water Analysis: Emerging Contaminants and Current Issues. *Analytical Chemistry*. **2011**, 83, 4614-4648.
- (24) World Health Organization. WHO Expert Committee on the Prevention of Cancer. *Wld. Hlth. Org. Techn. Rep. Ser.* **1964**, 276.
- (25) Kuster, M.; López de Alda, M.; Barceló, D. Liquid Chromatography-Tandem Mass Spectrometric Analysis and Regulatory Issues of Polar Pesticides in Natural and Treated Waters. *J. Chromatogr. A*. **2009**, 1216, 520-529.
- (26) Köck-Schulmeyer, M.; Villagrasa, M.; López de Alda, M.; Céspedes-Sánchez, R.; Ventura, F.; Barceló, D. Occurrence and Behavior of Pesticides in Wastewater Treatment Plants and Their Environmental Impact. *Science of the Total Environment*. **2013**, 458-460, 466-476.
- (27) Luo, Y.; Guo, W.; Ngo, H.H.; Nghiem, L.D.; Hai, F.I.; Zhang, J.; Liang, S.; Wang, X.C. A Review on the Occurrence of Micropollutants in the Aquatic Environment and Their Fate and Removal during Wastewater Treatment. *Science of the Total Environment*. **2014**, 473-474, 619-641.
- (28) Saleh, F.Y.; Lee, G.F.; Wolf, H.W. Selected Organic Pesticides, Occurrence, Transformation, and Removal from Domestic Wastewater. *Journal (Water Pollution Control Federation)*. **1980**, 52, 19-28.
- (29) Kolpin, D.W.; Barbash, J.E.; Gilliom, R.J. Occurrence of Pesticides in Shallow Groundwater of the United States: Initial Results from the National Water-Quality Assessment Program. *Environ. Sci. Technol.* **1998**, 32, 558-566.
- (30) Gilliom, R.J. Pesticides in U.S. Streams and Groundwater. *Environ. Sci. Technol.* **2007**, 41, 3408-3414.
- (31) Clark, C.S.; Meyer, C.R.; Gartside, P.S.; Majeti, V.A.; Specker, B.; Balistreri, W.F.; Elia, V.J. An Environmental Health Survey of Drinking Water Contamination by Leachate from a Pesticide Waste Dump in Hardeman County, Tennessee. *Archives of Environmental Health*. **1982**, 37, 9-18.
- (32) Zaki, M.H.; Moran, D.; Harris, D. Pesticides in Groundwater: The Aldicarb Story in Suffolk County, NY. *American Journal of Public Health*. **1982**, 72, 1391-1395.
- (33) Stone, W.W.; Gilliom, R.J.; Ryberg, K.R. Pesticides in U.S. Streams and Rivers: Occurrence and Trends During 1992-2011. *Environ. Sci. Technol.* **2014**, 48, 11025-11030.

- (34) Elias, D.; Bernot, M.J. Effects of Atrazine, Metolachlor, Carbaryl and Chlorothalonil on Benthic Microbes and Their Nutrient Dynamics. *PLOS One*. **2014**, 9, 1-7.
- (35) Younes, H.; Galal-Gorchev, H. Pesticides in Drinking Water – A Case Study. *Food and Chemical Toxicology*. **2000**, 38, S87-S90.
- (36) Rubio-Clemente, A.; Torres-Palma, R.A.; Peñuela, G.A. Removal of Polycyclic Aromatic Hydrocarbons in Aqueous Environment by Chemical Treatments: A Review. *Science of the Total Environment*. **2014**, 478, 201-225.
- (37) Samanta, S.K.; Singh, O.V.; Jain, R.K. Polycyclic Aromatic Hydrocarbons: Environmental Pollution and Bioremediation. *TRENDS in Biotechnology*. **2002**, 20, 243-248.
- (38) Mastrangelo, G.; Fadda, E.; Marzia, V. Polycyclic Aromatic Hydrocarbons and Cancer in Man. *Environ. Perspect*. **1996**, 104, 1166-1170.
- (39) Andelman, J.B.; Suess, M.J. Polynuclear Aromatic Hydrocarbons in the Water Environment. *Bull. Wld. Hlth. Org*. **1970**, 43, 479-508.
- (40) Nowacka, A.; Włodarczyk –Makuła, M. Monitoring of Polycyclic Aromatic Hydrocarbons in Water during Preparation Processes. *Polycyclic Aromatic Hydrocarbons*. **2013**, 33, 430-450.
- (41) Zena, R.; Speciale, A.; Calabrò, C.; Calò, M.; Palombieri, D.; Saija, A.; Cimino, F.; Trombetta, D.; Lo Cascio, P. Exposure of Sea Bream (*Sparus aurata*) to Toxic Concentrations of Ben[a]pyrene: Possible Human Health Effect. *Ecotoxicology and Environmental Safety*. **2015**, 122, 116-125.
- (42) Osorio-Yáñez, C.; García-Tavera, J.L.; Pérez-Núñez, M.T.; Poblete-Naredo, I.; Muñoz, B.; Barron-Vivanco, B.S.; Rothenberg, S.J.; Zapata-Pérez, O.; Albores, A. Benzo[a]pyrene Induces Hepatic AKR1A1 mRNA expression in Tilapia Fish (*Oreochromis niloticus*). *Toxicology Mechanisms and Methods*. **2012**, 22, 438-444.
- (43) Gonçalves, R.; Scholze, M.; Ferreira, A.M.; Martins, M.; Correia, A.D. The Joint Effect of Polycyclic Aromatic Hydrocarbons on Fish Behavior. *Environmental Research*. **2008**, 108, 205-213.
- (44) Dévier, M.; Le Dû-Lacoste, M.; Akcha, F.; Morin, B.; Peluhet, L.; Le Menach, K. Burgeot, T.; Budzinske, H. Biliary PAH Metabolites, EROD Activity and DNA Damage in Dab (*Limanda limanda*) from Seine Estuary (France). *Environ. Sci. Pollut. Res*. **2013**, 20, 708-722.

- (45) Westman, O.; Larsson, M.; Venizelos, N.; Hollert, H.; Engwall, M. An Oxygenated Metabolite of Benzo[a]pyrene Increases Hepatic β -oxidation of Fatty Acids in Chick Embryos. *Environ. Sci. Pollut. Res.* **2014**, 21, 6243-6251.
- (46) Malmquist, L.M.V.; Selck, H.; Jørgensen, K.B.; Christensen, J.H. Polycyclic Aromatic Acids are Primary Metabolites of Alkyl-PAHs – A Case Study with Nereis diversicolor. *Environ. Sci. Technol.* **2015**, 49, 5713-5721.
- (47) Zwiener, C.; Richardson, S.D. Analysis of Disinfection By-products in Drinking Water by LC-MS and Related MS Techniques. *Trends in Analytical Chemistry.* **2005**, 24, 613-621.
- (48) Zhao, Y.; Qin, F.; Boyd, J.M.; Anichina, J.; Li, X. Characterization and Determination of Chloro- and Bromo-Benzoquinones as New Chlorination Disinfection Byproducts in Drinking Water. *Anal. Chem.* **2010**, 82, 4599-4605.
- (49) Bellar, T.A.; Lichtenberg, J.J.; Kroner, R.C. The Occurrence of Organohalides in Chlorinated Drinking Waters. *Journal of the American Water Works Association.* **1974**, 66, 703-706.
- (50) Richardson, S.D.; Plewa, M. J.; Wagner, E.D. Occurrence, Genotoxicity, and Carcinogenicity of Regulated and Emerging Disinfection By-products in Drinking Water: A Review and Roadmap for Research. *Mutations Research/Reviews in Mutation Research.* **2007**, 636, 178-242.
- (51) Shah, A.D.; Mitch, W. Halonitroalkanes Halonitriles, Haloamides, and N-nitrosamines: A Critical Review of Nitrogenous Disinfection Byproduct Formation Pathways. *Environ. Sci. Technol.* **2012**, 46, 119-131.
- (52) Rook, J.T. Haloforms in Drinking Water. *Journal (American Water Works Association).* **1976**, 68, 168-176.
- (53) Zhang, H.; Zhang, Y.; Shi, Q.; Hu, J.; Chu, M.; Yu, J.; Yang, M.; Study on Transformation of Neutral Organic Matter in Source Water during Chlorination and its Chlorinated Products using Ultrahigh Resolution Mass Spectrometry. *Environ. Sci. Technol.* **2012**, 46, 4396-4402.
- (54) Westerhoff, P.; Chao, P.; Mash, H. Reactivity of Natural Organic Matter with Aqueous Chlorine and Bromine. *Water Research.* **2004**, 38, 1502-1513.
- (55) Zhang, X.; Minear, R.A.; Barrett, S.E. Characterization of High Molecular Weight Disinfection Byproducts from Chlorination of Humic Substances with/without

- Coagulation Pretreatment Using UF-SEC-ESI-MS/MS. *Environ. Sci. Technol.* **2005**, 39, 963-972.
- (56) Report on the Carcinogenesis Bioassay of Chloroform. Technical Report Series; U.S. Department of Health, Education, and Welfare, Public Health Services, National Institutes of Health: Bethesda, MD, **1976**.
- (57) Shaw, G.M.; Ranatunga, D.; Quach, T.; Neri, E.; Correa, A.; Neutra, R.R. Trihalomethane Exposures from Municipal Water Supplies and Selected Congenital Malformations. *Epidemiology.* **2003**, 14, 191-199.
- (58) Zhao, Y.; Anichina, J.; Lu, X.; Bull, R.J.; Krasner, S.W.; Hrudey, S.E.; Li, X. Occurrence and Formation of Chloro- and Bromo- Benzoquinones During Drinking Water Disinfection. *Water Research.* **2012**, 46, 4351-4360.
- (59) Zhang, H.; Zhang, Y.; Shi, Q.; Zheng, H.; Yang, M. Characterization of Unknown Brominated Disinfection Byproducts During Chlorination Using Ultrahigh Resolution Mass Spectrometry. *Environ. Sci. Technol.* **2014**, 48, 3112, 3119.
- (60) Sharma, V.K.; Zboril, R.; McDonald, T.J. Formation and Toxicity of Brominated Disinfection Byproducts during Chlorination and Chloramination of Water: A Review. *Journal of Environmental Science and Health, Part B.* **2014**, 49, 212-228.
- (61) Yeh, R.Y.L; Farré, M.J.; Stalter, D.; Tang, J.Y.M.; Molendijk, J.; Escher, B.I. Bioanalytical and Chemical Evaluation of Disinfection By-products in Swimming Pool Water. *Water Research.* **2014**, 59, 172-184.
- (62) Lourencetti, C.; Grimalt, J.O.; Marco, E.; Fernandez, P.; Font-Ribera, L.; Villanueva, C.M.; Kogevinas, M. Trihalomethanes in Chlorine and Bromine Disinfected Swimming Pools: Air-water Distributions and Human Exposure. *Environment International.* **2012**, 45, 59-67.
- (63) Richardson, S.D.; DeMarini, D.M.; Kogevinas, M.; Fernandez, P.; Marco, E.; Lourencetti, C.; Ballesté, C.; Heederik, D.; Meliefste, K.; McKague, A.B.; Marcos, R.; Font-Ribera, L.; Grimalt, J.O.; Villanueva, C.M. What's in the Pool? A Comprehensive Identification of Disinfection By-products, and Assessment of Mutagenicity of Chlorinated and Brominated Swimming Pool Water. *Environmental Health Perspectives.* **2010**, 118, 1523-1530.
- (64) Xiao, F.; Zhang, X.; Zhai, H.; Lo, I.M.C.; Tipoe, G.L.; Yank, M.; Pan, Y.; Chen, G. New Halogenated Disinfection Byproducts in Swimming Pool Water and Their Permeability across Skin. *Environ. Sci. Technol.* **2012**, 46, 7112-7119.

- (65) Aggazzotti, G.; Fantuzzi, G.; Tartoni, P.L.; Predieri, G. Plasma Chloroform Concentrations in Swimmers Using Indoor Swimming Pools. *Archives of Environmental Health*. **1990**, 45, 175-179.
- (66) Kogevinas, M.; Villanueva, C.M.; Font-Ribera, L.; Liviach, D.; Bustamante, M.; Espinoza, F.; Nieuwenhuijsen, M.J.; Espinosa, A.; Fernandez, P.; Demarini, D.M.; Grimalt, J.O.; Grummt, T.; Marcos, R. Genotoxic Effects in Swimmers Exposed to Disinfection By-products in Indoor Swimming Pools. *Environmental Health Perspectives*. **2010**, 118, 1531-1537.
- (67) Parkison, A. Biotransformation of Xenobiotics. In *Casarett & Doull's Essentials of Toxicology*. Klaassen, C.D.; Watkins, J.B., Eds. McGraw-Hill: Chicago, **2003**; pp 71-97.
- (68) Stine, K.E.; Brown, T.M. Biotransformation. *Principles of Toxicology*. Taylor & Francis Group: New York, **2009**; pp 27-48.
- (69) Lakind, J.S.; Richardson, S.D.; Blount, B.C. The Good, the Bad, and the Volatile: Can We Have Both Healthy Pools and Healthy People? *Environ. Sci. Technol.* **2010**, 44, 3205-3210.
- (70) Liviach, D.; Wagner, E.D.; Mitch, W.A.; Altonji, M.J.; Plewa, M.J. Genotoxicity of Water Concentrates from Recreational Pools after Various Disinfection Methods. *Environ. Sci. Technol.* **2010**, 44, 3527-3532.
- (71) Kolpin, D.W.; Furlong, E.T.; Meyer, M.T.; Thurman, E. M.; Zaugg, S.D.; Barber, L.B.; Buxton, H.T. Pharmaceuticals, Hormones, and Other Organic Wastewater Contaminants in U.S. Streams, 1999 – 2000: A National Reconnaissance. *Environ. Sci. Technol.* **2002**, 36, 1202-1211.
- (72) Vanderford, B.J.; Pearson, R.A.; Rexing, D.J.; Snyder, S.A. Analysis of Endocrine Disruptors, Pharmaceuticals, and Personal Care Products in Water Using Liquid Chromatography/Tandem Mass Spectrometry. *Anal. Chem.* **2003**, 75, 6265-6274.
- (73) Kasprzyk-Hordern, B.; Dinsdale, R.M. Multiresidue Methods for the Analysis of Pharmaceuticals, Personal Care Products and Illicit Drugs in Surface Water and Wastewater by Solid-phase Extraction and Ultra Performance Liquid Chromatography – Electrospray Tandem Mass Spectrometry. *Anal. Bioanal. Chem.* **2008**, 391, 1293-1308.
- (74) Kanda, R.; Griffin, P.; James, H.A.; Fothergill, J. Pharmaceutical and Personal Care Products in Sewage Treatment Works. *J. Environ. Monit.* **2003**, 5, 823-830.

- (75) Loraine, G.A.; Pettigrove, M.E. Seasonal Variations in Concentrations of Pharmaceuticals and Personal Care Products in Drinking Water and Reclaimed Wastewater in Southern California. *Environ. Sci. Technol.* **2006**, *40*, 687-695.
- (76) Maranhão, L.A.; Garrido-Pérez, M.C.; Baena-Nogueras, R.M.; Lara-Martín, P.A.; Antón-Martín, R.; DelValls, T.A.; Martín-Díaz, M.L. Are WWTPs Effluents Responsible for Acute Toxicity? Seasonal Variations of Sediment Quality at the Bay of Cádiz (SW, Spain). *Ecotoxicology*. **2015**, *24*, 368-380.
- (77) Bound, J.P.; Voulvoulis, N. Household Disposal of Pharmaceuticals as a Pathway for Aquatic Contamination in the United Kingdom. *Environmental Health Perspectives*. **2005**, *113*, 1705-1711.
- (78) Kümmerer, K. Drugs in the Environment: Emission of Drugs, Diagnostic Aids and Disinfectants into Wastewater by Hospitals in Relation to Other Sources – a Review. *Chemosphere*. **2001**, 957-969.
- (79) Verlicchi, P.; Galletti, A.; Petrovic, M.; Barceló, D. Hospital Effluents as a Source of Emerging Pollutants: An Overview of Micropollutants and Sustainable Treatment Options. *Journal of Hydrology*. **2010**, *389*, 416-428.
- (80) Brown, K.D.; Kulis, J.; Thomson, B.; Chapman, T.H.; Mawhinney, D.B. Occurrence of Antibiotics in Hospital, Residential, and Dairy Effluent, Municipal Wastewater, and the Rio Grande in New Mexico. *Science of the Total Environment*. **2006**, *366*, 772-783.
- (81) Corcoran, J.; Winter, M.J.; Tyler, C.R. Pharmaceuticals in the Aquatic Environment: A Critical Review of the Evidence for Health Effects in Fish. *Critical Reviews in Toxicology*. **2010**, *40*, 287-304.
- (82) Kümmerer, K.; Henninger, A. Promoting Resistance by the Emission of Antibiotics from Hospitals and Households into Effluent. *Clin. Microbiol. Infect.* **2003**, *9*, 1203-1214.
- (83) Calisto, V.; Esteves, V.I. Psychiatric Pharmaceuticals in the Environment. *Chemosphere*. **2009**, *77*, 1257-1274.
- (84) Fent, K.; Weston, A.A.; Caminada, D. Ecotoxicology of Human Pharmaceuticals. *Aquatic Toxicology*. **2006**, *76*, 122-159.

- (85) Pedrouzo, M.; Borrull, F.; Marcé, R.M.; Pocurull, E. Simultaneous Determination of Macrolides, Sulfonamides, and other Pharmaceuticals in Water Samples by Solid-Phase Extraction and LC-(ESI) MS. *J. Sep. Sci.* **2008**, 31, 2182-2188.
- (86) Pedrouzo, M.; Borrull, F.; Pocurull, E.; Marcé, R.M. Presence of Pharmaceuticals and Hormones in Waters from Sewage Treatment Plants. *Water Air Soil Pollut.* **2011**, 217, 267-281.
- (87) Santos, L.H.M.L.M.; Araújo, A.N.; Fachini, A.; Pena, A.; Delerue-Matos, C.; Montenegro, M.C.B.S.M. Ecotoxicological Aspects Related to the Presence of Pharmaceuticals in the Aquatic Environment. *Journal of Hazardous Materials.* **2010**, 175, 45-95.
- (88) Ritter, J.K. Roles of Glucuronidation and UDP-glucuronosyltransferases in Xenobiotic Bioactivation Reactions. *Chemico-Biological Interactions.* **2000**, 129, 171-193.
- (89) Hignite, Charles; Azzarmoff, Daniel L. Drugs and Drug Metabolites as Environmental Contaminants: Chlorophenoxyisobutyrate and Salicylic Acid in Sewage Water Effluent. *Life Sciences.* **1977**, 20, 337-341.
- (90) Wishart, D.S.; Knox, C.; Guo, A.C.; Cheng, D.; Shrivastava, S.; Tzur, D.; Gautam, B.; Hassanali, M. DrugBank: A Knowledgebase for Drugs, Drug Actions and Drug Targets. *Nucleic Acids Research.* **2008**, 36 (Database issue), D901-D906.
- (91) Ferrer, I.; Thurman, E.M. Identification of a New Antidepressant and its Glucuronide Metabolite in Water Samples Using Liquid Chromatography/Quadrupole Time-of-Flight Mass Spectrometry. *Anal. Chem.* **2010**, 82, 8161-8168.
- (92) Sunkara, M.; Wells, M.J.M. Phase II Pharmaceutical Metabolites, Acetaminophen Glucuronide and Acetaminophen Sulfate in Wastewater. *Environmental Chemistry.* **2010**, 7, 111-122.
- (93) Miao, X.; Yang, J.; Metcalfe, C.D. Carbamazepine and its Metabolites in Wastewater and in Biosolids in a Municipal Wastewater Treatment Plant. *Environ. Sci. Technol.* **2005**, 39, 7469-7475.
- (94) Ye, X.; Kuklennyik, Z.; Needham, L.L. Calafat, A.M. Automated On-Line Column-Switching HPLC-MS/MS Method with Peak Focusing for the Determination of Nine Environmental Phenols in Urine. *Anal. Chem.* **2005**, 77, 5407-5413.

- (95) Santana, C.M.; Ferrera, Z.S.; Torres Padrón, M.E.; Santana Rodríguez, J.J. Methodologies for the Extraction of Phenolic Compounds from Environmental Samples: New Approaches. *Molecules*. **2009**, *14*, 298-320.
- (96) Stapleton, H.M.; Sharma, S.; Getzinger, G.; Ferguson, P.L.; Gabriel, M.; Webster, T.F.; Blum, A. Novel and High Volume Use Flame Retardants in US Couches Reflective of the 2005 PentaBDE Phase Out. *Environmental Science & Technology*. **2012**, *46*, 13432-13439.
- (97) Dash, C.; Marcus, M.; Terry, P.D. Bisphenol A: Do Recent Studies of Health Effects Among Humans Inform the Long-Standing Debate? *Mutation Research/Reviews in Mutation Research*. **2006**, *613*, 68-75.
- (98) Vandenberg, L.N.; Maffini, M.V.; Sonnenschein, C.; Rubin, B.S.; Soto, A.M. Bisphenol-A and the Great Divide: A Review of Controversies in the Field of Endocrine Disruption. *Endocrine Reviews*. **2009**, *30*, 75-95.
- (99) Kang, J.; Aasi, D.; Katayama, Y. Bisphenol A in the Aquatic Environment and its Endocrine-Disruptive Effects on Aquatic Organisms. *Critical Reviews in Toxicology*. **2007**, *37*, 607-625.
- (100) Rubin, B.S.; Murray, M.K.; Damassa, D.A.; King, J.C.; Soto, A.M. Perinatal Exposure to Low Doses of Bisphenol A Affects Body Weight, Patterns of Estrous Cyclicity, and Plasma LH Levels. *Environmental Health Perspectives*. **2001**, *109*, 675-680.
- (101) Matthew, J.B.; Twomey, K.; Zacharewski, T.R. In Vitro and in Vivo Interactions of Bisphenol A and its Metabolite, Bisphenol A Glucuronide, with Estrogen Receptors α and β . *Chemical Research in Toxicology*. **2001**, *14*, 149-157.
- (102) Yoshino, S.; Yamaki, K.; Li, X.; Sai, T.; Yanagisawa, R.; Takano H.; Taneda, S.; Hayashi, H.; Mori, Y. Prenatal Exposure to Bisphenol A Up-Regulates Immune Responses, Including T helper 1 and T helper 2 responses, in mice. *Immunology*. **2004**, *112*, 489-495.
- (103) Lang, I.A.; Galloway, T.S.; Scarlett, A.; Henley, W.E.; Depledge, M.; Wallace, R.B.; Melzer D. Association of Urinary Bisphenol A Concentration with Medical Disorders and Laboratory Abnormalities in Adults. *JAMA*. **2007**, *300*, 1303-1310.
- (104) Melzer, D.; Rice, N.E.; Lewis, C.; Henley, W.E.; Galloway, T.S. Association of Urinary Bisphenol A Concentration with Heart Disease: Evidence from NHANES 2003/2006. *PLOS One*. **2010**, *5*, 1-9.

- (105) Carwile, J.L.; Michels, K.B. Urinary Bisphenol A and Obesity: NHANES 2003-2006. *Environmental Research*. **2011**, 111, 825-830.
- (106) Fang, J.; Stingley, R.L.; Beland, F.A.; Harrouk, W.; Lumpkins, D.L.; Howard, P. Occurrence, Efficacy, Metabolism, and Toxicity of Triclosan. *Journal of Environmental Science and Health, Part C*. **2010**, 28, 147-171.
- (107) Jones, R.D.; Jampani, H.B.; Newman, J.L.; Lee, A.S. Triclosan: A Review of Effectiveness and Safety in Health Care Settings. *American Journal of Infection Control*. **2000**, 184-196.
- (108) Bedoux, G.; Roig, B.; Thomas, O.; Dupont, V.; Le Bot, B. Occurrence and Toxicity of Antimicrobial Triclosan and By-Products in the Environment. *Environ. Sci. Pollut. Res*. **2012**, 19, 1044-1065.
- (109) Bhargave, H.N.; Leonard, P.A. Triclosan: Applications and Safety. *American Journal of Infection Control*. **1996**, 24, 209-218.
- (110) Jobling, S.; Reynolds, T.; White, R.; Parker, M.G.; Sumpter, J.P. A Variety of Environmentally Persistent Chemicals, Including Some Phthalate Plasticizers, Are Weakly Estrogenic. *Environ. Health Perspect*. **1995**, 103, 582-587.
- (111) Michałowicz, J.; Duda, W. Phenols – Sources and Toxicity. *Polish J. of Environ. Stud*. **2007**, 16, 347-362.
- (112) Rule, K.L.; Ebbett, V.R.; Vikesland, P.J. Formation of Chloroform and Chlorinated Organics by Free-Chlorine-Mediated Oxidation of Triclosan. *Environ. Sci. Technol*. **2005**, 39, 3176-3185.
- (113) Latch, D.E.; Packer, J.L.; Stender, B.L.; VanOverbeke, J.; Arnold, W.A.; McNeill, K. Aqueous Photochemistry of Triclosan: Formation of 2,4-dichlorophenol, 2,8-dichlorodibenzo-p-dioxin, and Oligomerization Products. *Environmental Toxicology and Chemistry*. 2005, 24, 517-525.
- (114) Sankoda, K.; Matsuo, H.; Ito, M.; Nomiya, K.; Arizono, K.; Shinohara, R. Identification of Triclosan Intermediates Produced by Oxidative Degradation Using TiO₂ in Pure Water and Their Endocrine Disrupting Activities. *Bull. Environ. Contam. Toxicol*. 2011, 86, 470-475.
- (115) Environmental Protection Agency. Final Updated Ambient Water Quality Criteria for the Protection of Human Health. *Fed. Regist*. 2015, 80, 36986-36989.

- (116) Munoz, M.; de Pedro, Z.M.; Casas, J.A.; Rodriguez, J.J. Triclosan Breakdown by Fenton-like Oxidation. *Chemical Engineering Journal*. 2012, 198-199, 275-281.
- (117) Rubinson, K.A.; Rubinson, J.F. Mass Spectrometry. *Contemporary Instrumental Analysis*. Prentice Hall: Upper Saddle River, NJ, 2000; pp 514-575.
- (118) Watson, J.T.; Sparkman, O.D. *Introduction to Mass Spectrometry*, 4th ed. Wiley: West Sussex, England, 2007.
- (119) Silverstein, R.M.; Webster, F.X.; Kiemle, D.J. Mass Spectrometry. *Spectrometric Identification of Organic Compounds*, 7th ed. John Wiley & Sons, Inc.: Hoboken, NJ, 2005; pp 1-71.
- (120) Florián, J.; Gao, L.; Zhukhovskyy, V.; MacMillan, D.K.; Chiarelli, M.P. Nitramine Anion Fragmentation: A Mass Spectrometric and Ab Initio Study. *J. Am. Soc. Mass Spectrom.* **2007**, 18, 835-841.
- (121) Skoog, D.A.; Holler, F.J.; Crouch, S.R. Molecular Mass Spectrometry. *Principles of Instrumental Analysis*, 6th ed. Thomson Brooks/Cole: Belmont, CA, 2007; pp. 550-588.
- (122) March, R.E. An Introduction to Quadrupole Ion Trap Mass Spectrometry. *Journal of Mass Spectrometry*. **1997**, 32, 351-369.
- (123) Triple Quadrupole MS. <http://www.rzuser.uni-heidelberg.de/~bl5/ency/triplequadms.html> (Accessed February 18, 2016).
- (124) Douglas, D.J. Linear Quadrupoles in Mass Spectrometry. *Mass Spectrometry Reviews*. **2009**, 28, 937-960.
- (125) Converging Annular Time-of-flight Mass Spectrometer. http://www.kore.co.uk/ms-200_principles.htm (Accessed February 19, 2016).
- (126) Hu, Q.; Noll, R.J.; Li, H.; Makarov, A.; Hardman, M.; Cooks, R.G. The Orbitrap: A New Mass Spectrometer. *Journal of Mass Spectrometry*. **2005**, 40, 430-443.
- (127) Makarov, A.; Muenster, H. Breakthrough Technology for Bottom-Up Proteomics and Small Molecule Research. <http://www.americanlaboratory.com/914-Application-Notes/18815-Breakthrough-Technology-for-Bottom-Up-Proteomics-and-Small-Molecule-Research/> (Accessed February 19, 2016).

- (128) Fourier Transform Ion Cyclotron Resonance Mass Spectrometry. <http://jlab.chem.yale.edu/research/techniques/fourier-transform-icr> (Accessed February 22, 2016).
- (129) Microchannel Plates. http://www.dmpotonics.com/MCP_MCPIImageIntensifiers/microchannel_plates.htm (Accessed February 25, 2016).
- (130) Drinking Water Contaminant List (CCL) and Regulatory Determination. U.S. Environmental Protection Agency. www2.epa.gov/ccl (Accessed October 28, 2014).
- (131) Gheorge, A.; van Nuijs, A.; Pecceu, B.; Bervoets, L.; Jorens, P.G.; Blust, R.; Neels, H.; Covaci, A. Analysis of Cocaine and its Principal Metabolites in Waste and Surface Water Using Solid-Phase Extraction and Liquid Chromatography-Ion Trap tandem Mass Spectrometry. *Anal. Bioanal. Chem.* **2008**, 391, 1309-1319.
- (132) Loos, R.; Barceló, D. Determination of Haloacetic Acids in Aqueous Environments by Solid-Phase Extraction Followed by Ion-Pair Liquid Chromatography-Electrospray Ionization Mass Spectrometric Detection. *Journal of Chromatography A.* **2001**, 938, 45-55.
- (133) de Almeida Azevedo, D.; Lacorte, S.; Vinhas, T.; Viana, P.; Barceló, D. Monitoring of Priority Pesticides and Other Organic Pollutants in River Water from Portugal by Gas-Chromatography-Mass Spectrometry and Liquid Chromatography-Atmospheric Pressure Chemical Ionization Mass Spectrometry. *Journal of Chromatography A.* **2000**, 879, 13-26.
- (134) Loos, R.; Hanke, G.; Eisenreich, S.J. Multi-component Analysis of Polar Water Pollutants Using Sequential Solid-Phase Extraction Followed by LC-ESI-MS. *J. Environ. Monit.* **2003**, 5, 384-394.
- (135) Stolker, A.A.M.; Niesing, W.; Hogendroorn, E.A.; Versteegh, J.F.M.; Fuchs, R.; Brinkman, U.A.T. Liquid Chromatography with Triple-Quadrupole or Quadrupole-Time of Flight Mass Spectrometry for Screening and Confirmation of Residues of Pharmaceuticals in Water. *Analytical and Bioanalytical Chemistry.* **2004**, 378, 955-963.
- (136) Duan, J.; Li, W.; Si, J.; Mulcahy, D. Rapid Determination of Nine Haloacetic Acids in Water Using Ultra-performance Liquid Chromatography-Tandem Mass Spectrometry in Multiple Reactions Monitoring Mode. *Analytical Methods.* **2011**, 3, 1667-1673.

- (137) Völkel, W.; Bittner, N.; Dekant, W. Quantitation of Bisphenol A and Bisphenol A Glucuronide in Biological Samples by High Performance Liquid Chromatography-Tandem Mass Spectrometry. *Drug Metabolism and Disposition*. **2005**, 33, 1748-1757.
- (138) Levsen, K.; Schiebel, H.; Behnke, B.; Dötzer, R.; Dreher, W.; Elend, M.; Thiele, H. Structure Elucidation of Phase II Metabolites by Tandem Mass Spectrometry: and Overview. *Journal of Chromatography A*. **2005**, 1067, 55-72.
- (139) Prakash, C.; Shaffer, C.L.; Nedderman, A. Analytical Strategies for Identifying Drug Metabolites. *Mass Spectrometry Reviews*. **2007**, 26, 340-369.
- (140) McLafferty, F.W.; Tureček, F. *Interpretation of Mass Spectra*, 4th ed. University Science Books: Sausalito, CA, 1993.
- (141) Ternes, T.; Bonerz, M.; Schmidt, T. Determination of Neutral Pharmaceuticals in Wastewater and Rivers by Liquid Chromatography-Electrospray Tandem Mass Spectrometry. *Journal of Chromatography A*. **2001**, 175-185.
- (142) Ding, G.; Zhang, X. A Picture of Polar Iodinated Disinfection Byproducts in Drinking Water by (UPLC/ESI-tqMS). *Environ. Sci. Technol.* **2009**, 43, 9287-9293.
- (143) Zedda, M.; Zwiener, C. Is Nontarget Screening of Emerging Contaminants by LC-HRMS Successful? A Plea for Compounds Libraries and Computer Tools. *Analytical and Bioanalytical Chemistry*. **2012**, 403, 2493-2502.
- (144) Little, J.L.; Cleven, C.D.; Brown, S.D. Identification of "Known Unknowns" Utilizing Accurate Mass Data and Chemical Abstracts Databases. *J. Am. Soc. Mass Spectrom.* **2011**, 22, 348-359.
- (145) Little, J.L.; Williams, A.J.; Pshenichnov, A.; Tkachenko, V. Identification of "Known Unknowns" Utilizing Accurate Mass Data and ChemSpider. *J. Am. Soc. Mass Spectrom.* **2012**, 23, 179-185.
- (146) Ferrer, I.; Thurman, E.M. Liquid Chromatography/Time-of-flight/Mass Spectrometry (LC/TOF/MS) for the Analysis of Emerging Contaminants. *Trends in Analytical Chemistry*. **2003**, 22, 750-756.
- (147) Ibáñez, M.; Sancho, J.V.; McMillan, D.; Rao, R.; Hernández, F. Rapid Non-target Screening of Organic Pollutants in Water by Ultraperformance Liquid Chromatography Coupled to Time-of-flight Mass Spectrometry. *Trends in Analytical Chemistry*. **2008**, 27, 481-489.

- (148) Bobeldijk, I.; Vissers, J.P.C.; Kearney, G.; Major, H.; van Leerdam, J.A. Screening and Identification of Unknown Contaminants in Water with Liquid Chromatography and Quadrupole-orthogonal Acceleration-time-of-flight Tandem Mass Spectrometry. *Journal of Chromatography A*. **2001**, 929, 63-74.
- (149) Patiny, L.; Borel, A. ChemCalc: A Building Block for Tomorrow's Chemical Infrastructure. *J. Chem. Inf. Model.* **2013**, 53, 1223-1228.
- (150) ChemSpider Home Page. www.chemspider.com (Accessed December 29, 2015).
- (151) Thurman, E. M.; Ferrer, I. The Isotopic Mass Defect: a Tool for Limiting Molecular Formulas by Accurate Mass. *Analytical and Bioanalytical Chemistry*. **2010**, 397, 2807-2816.
- (152) Ibáñez, M.; Sancho, J.V.; Pozo, Ó.J.; Niessen, W.; Hernández, F. Use of Quadrupole Time-of-Flight Mass Spectrometry in the Elucidation of Unknown Compounds Present in Environmental Water. *Rapid Communications in Mass Spectrometry*. **2005**, 19, 169-178.
- (153) Ouyang, X.; Leonards, P.; Legler, J.; van der Oost, R.; de Boer, J.; Lamoree, M. Comprehensive Two-Dimensional Liquid Chromatography Coupled to High Resolution Time of Flight Mass Spectrometry for Chemical Characterization of Sewage Treatment Plant Effluents. *Journal of Chromatography A*. **2015**, 1380, 139-145.
- (154) Matamoros, V.; Jover, E.; Bayona, J.M. Part-per-Trillion Determination of Pharmaceuticals, Pesticides, and Related Organic Contaminants in River Water by Solid-Phase Extraction Followed by Comprehensive Two-Dimensional Gas Chromatography Time-of-Flight Mass Spectrometry. *Anal. Chem.* **2010**, 82, 699-706.
- (155) Hernández, F.; Portolés, T.; Pitarch, E.; López, F.J. Target and Nontarget Screening of Organic Micropollutants in Water by Solid-Phase Microextraction Combined with Gas Chromatography/High-Resolution Time-of-Flight Mass Spectrometry. *Anal. Chem.* **2007**, 79, 9494-9504.
- (156) Jernberg, J.; Pellinen, J.; Rantalainen, A. Qualitative Nontarget Analysis of Landfill Leachate Using Gas Chromatography Time-of-Flight Mass Spectrometry. *Talanta*. **2013**, 103, 384-391.
- (157) Portolés, T.; Pitarch, E.; López, E.; Hernández, F.; Niessen, W.M.A. Use of Soft and Hard Ionization Techniques for Elucidation of Unknown Compounds by Gas

Chromatography/Time-of-Flight Mass Spectrometry. *Rapid Commun. Mass Spectrom.* **2011**, 25, 1589-1599.

- (158) Pinhancos, R.; Maass, S.; Ramanathan, D.M. High-Resolution Mass Spectrometry Method for the Detection, Characterization and Quantitation of Pharmaceuticals in Water. *Journal of Mass Spectrometry.* **2011**, 46, 1175-1181.
- (159) Krauss, M.; Hollender, J. Analysis of Nitrosamines in Wastewater: Exploring the Trace Level Quantification Capabilities of a Hybrid Linear Ion Trap/Orbitrap Mass Spectrometer. *Anal. Chem.* **2008**, 80, 834-842.
- (160) Rowland, S.J.; Pereira, A.S.; Martin, J.W.; Scarlett, A.G.; West, C.E.; Lengger, S.K.; Wilde, M.J.; Pureveen, J.; Tegelaar, E.W.; Frank, R.A.; Hewitt, L.M. Mass Spectral Characterization of a Polar, Esterified Fraction of an Organic Extract of an Oil Sands Process Water. *Rapid Commun. Mass Spectrom.* **2014**, 28, 2352-2362.
- (161) Barron, L.; Paull, B. Determination of Haloacetic Acids in Drinking Water Using Suppressed Micro-bore Ion Chromatography with Solid Phase Extraction. *Analytica Chimica Acta.* **2004**, 522, 153-161.
- (162) Ying-xue, S.; Ping, G. Determination of Haloacetic Acids in Hospital Effluent after Chlorination by Ion Chromatography. *Journal of Environmental Sciences.* **2007**, 19, 885-891.
- (163) Oliveira, T.M.B.F.; Pessoa, G.P.; dos Santos, A.B.; de Lima-Neto, P.; Correia, A.N. Simultaneous Electrochemical Sensing of Emerging Organic Contaminants in Full-Scale Sewage Treatment Plants. *Chemical Engineering Journal.* **2015**, 267, 347-354.
- (164) Nunes, C.N.; Pauluk, L.E.; dos Anjos, V.E.; Lopes, M.C.; Quináia, S.P. New Approach to the Determination of Contaminants of Emerging Concern in Natural Water: Study of Alprazolam Employing Adsorptive Cathodic Stripping Voltammetry. *Anal. Bioanal. Chem.* **2015**, 407, 6171-6179.
- (165) Montagner, C.C.; Jardim, W.F. Spatial and Seasonal Variations of Pharmaceuticals and Endocrine Disruptors in the Atibaia River, São Paulo State (Brazil). *J. Braz. Chem. Soc.* **2011**, 22, 1452-1462.
- (166) Salvatierra-Stamp, V. del Carmen; Ceballos-Magaña, S.G.; Ibarra-Galván, V.; Muñoz-Valencia, R. Analytical Method Development for the Determination of Emerging Contaminants in Water Using Supercritical-Fluid Chromatography Coupled with Diode-Array Detection. *Anal. Bioanal. Chem.* **2015**, 407, 4219-4226.

- (167) Preiss, A.; Godejohann, M. Applications of NMR Techniques for the Identification and Structure Elucidation of Emerging Organic and Other Xenobiotic Organic Contaminants. In *Transformation Products of Emerging Contaminants in the Environment: Analysis, Processes, Occurrence, Effects and Risks*, 1st ed.; Lambropoulou, D.A., Nollet, L.M.L. Eds.; John Wiley & Sons, Ltd.: United Kingdom, **2014**, pp 351-384.
- (168) Godejohann, M. Environmental NMR: Hyphenated Methods. *eMagRes*. **2013**, 2, 477-492.
- (169) Simpson, A.J.; Tseng, L.; Simpson, M.T.; Spraul, M.; Braumnaa, U.; Kingery, W.L.; Kelleher, B.P.; Hayes, M.H.B. The Application of LC-NMR and LC-SPE-NMR to Compositional Studies of Natural Organic Matter. *The Analyst*. **2004**, 129, 1216-1222.
- (170) van Leerdam, J.A.; Vervoort, J.; Stroomberg, G.; de Voogt, P. Identification of Unknown Microcontaminants in Dutch River Water by Liquid Chromatography – High Resolution Mass Spectrometry and Nuclear Magnetic Resonance Spectroscopy. *Environ. Sci. Technol.* **2014**, 48, 12791-12799.
- (171) Munch, D.J.; Munch, J.W.; Pawlecki, A.M. Method 552.2: Determination of Haloacetic Acids and Dalapon in Drinking Water by Liquid-Liquid Extraction, Derivatization, and Gas Chromatography with Electron Capture Detection. National Exposure Research Laboratory, Office of Research and Development, U.S. Environmental Protection Agency: Cincinnati, Ohio, **1995**.
- (172) Method 501.2: The Analysis of Trihalomethanes in Drinking Water by Liquid/Liquid Extraction. Environmental Monitoring and Support Laboratory, Office of Research and Development, U.S. Environmental Protection Agency: Cincinnati, Ohio, **1979**.
- (173) Liu, W.; Andrews, S.A.; Stefan, M.I.; Bolton, J.R. Optimal Methods for Quenching H₂O₂ Residuals Prior to UFC Testing. *Water Research*. **2003**, 37, 3697-3703.
- (174) Crutchfield, C.A.; Olson, M.T.; Gourgari, E.; Nesterova, M.; Stratakis, C.A.; Yergey, A.L. Comprehensive Analysis of LC/MS Data Using Pseudocolor Plots. *J. Am. Soc. Mass Spectrom.* **2013**, 24, 230-237.
- (175) Parris, S. The Chemical Treatment of Swimming Pool Water. *ChemSA*. **1987**, 107-110.

- (176) Zwiener, C.; Richardson, S.D.; De Marini, D.M.; Grummt, T.; Glauner, T.; Frimmel, F.H. Drowning in Disinfection Byproducts? Assessing Swimming Pool Water. *Environ. Sci. Technol.* **2007**, 41, 363-372.
- (177) Gopal, K.; Tripathy, S.S.; Bersillon, J.L.; Dubey, S.P. Chlorination Byproducts, Their Toxicodynamics and Removal from Drinking Water. *Journal of Hazardous Materials.* **2007**, 140, 1-6.
- (178) Budzikiewicz, H. Negative Chemical Ionization (NCI) of Organic Compounds. *Mass Spectrometry Reviews.* **1986**, 5, 345-380.
- (179) Buser, H. Selective Detection of Brominated Aromatic Compounds Using Gas Chromatography/Negative Chemical Ionization Mass Spectrometry. *Anal. Chem.* **1986**, 58, 2913-2919.
- (180) Christiansen, C.J.; Francisco, J.S. Atmospheric Oxidation Mechanism of 1,2-Dibromoethane. *J. Phys. Chem. A.* **2009**, 113, 7189-7204.
- (181) Anbar, M.; Neta, P. Reactions of Halogenoaliphatic Acids with Free Radicals in Aqueous Solution. Part II. Reactions with Aliphatic Free Radicals. *Inorg. Phys. Theor.* **1967**, 5, 837-841.
- (182) Understanding Your Sewer: An Introduction to the Chicago Area's Combined Sewer Systems. Metropolitan Water Reclamation District of Greater Chicago. https://www.vah.com/assets/1/public_works/Understanding_Your_Sewer.pdf (Accessed November 15, 2013).
- (183) Exner, J.H.; Burk, G.A.; Kyriacou, D. Rates and Products of Decomposition of 2,2-Dibromo-3-nitrilopropionamide. *J. Agr. Food Chem.* **1973**, 21, 838-842.
- (184) Jung, J.; Furutani, H.; Uematsu, M.; Park, J. Distributions of Atmospheric Non-Sea-Salt Sulfate and Methanesulfonic Acid Over the Pacific Ocean Between 48°N and 55°S During Summer. *Atmospheric Environment.* **2014**, 99, 374-384.
- (185) Aranami, K.; Watanabe, S.; Tsunogai, S.; Ohki, A.; Miura, K.; Kojima, H. Chemical Assessment of Oceanic and Terrestrial Sulfur in the Marine Boundary Layer Over the Northern North Pacific During Summer. *Journal of Atmospheric Chemistry.* **2002**, 41, 49-66.
- (186) Grogan, J.; DeVito, S.C.; Pearlman, R.S.; Korzekwa, K.R. Modeling Cyanide Release from Nitriles: Prediction of Cytochrome P450 Mediated Acute Nitrile Toxicity. *Chem. Res. Toxicol.* **1992**, 5, 548-552.

- (187) Wang, Q.; Lutz, M.; Reichert, M.; Becker, D.P.; Chiarelli, M.P. New Analytical Approaches for the Detection of Micropollutants of 3,5-Dichloro-4-Hydroxybenzene Sulfonic Acid as an Unknown Persistent Pollutant. In *Surface Water Photochemistry*; Claza, P. and Vione, D., Eds.; Comprehensive Series in Photochemical and Photobiological Sciences; The Royal Society of Chemistry: Cambridge, UK, 2016; Vol. 12, pp 239-256.
- (188) Dann, A.B.; Hontela, A. Triclosan: Environmental Exposure, Toxicity and Mechanisms of Action. *J. Appl. Toxicol.* **2010**, 31, 285-311.
- (189) Saleh, S.; Haddadin, R.N.S.; Baillie, S.; Collier, P.J. Triclosan – an Update. *Letters in Applied Microbiology.* **2010**, 52, 87-95.
- (190) Guillén, J.; Bernabeu, A.; Shapiro, S.; Villalaín, J. Location and Orientation of Triclosan in Phospholipid Model Membranes. *Eur. Biophys. J.* **2004**, 33, 448-453.
- (191) Boleda, M.R.; Alechaga, E.; Moyano, E.; Galceran, M.T.; Ventura, F. Survey of the Occurrence of Pharmaceuticals in Spanish Finished Drinking Waters. *Environ. Sci. Pollut. Res.* **2014**, 21, 10917-10939.
- (192) Li, S.; Ying, G.; Su, H.; Yang, X.; Wang, L. Simultaneous Determination and Assessment of 4-Nonylphenol, Bisphenol A and Triclosan in Tap Water, Bottled Water, and Baby Bottles. *Environment International.* **2010**, 36, 557-562.
- (193) Wang, C.; Tian, Y. Reproductive Endocrine-Disrupting Effects of Triclosan: Population Exposure, Present Evidence and Potential Mechanisms. *Environmental Pollution.* **2015**, 206, 195-201.
- (194) Canosa, P.; Morales, S.; Rodríguez, I.; Rubí, E.; Cela, R.; Gómez, M. Aquatic Degradation of Triclosan and Formation of Toxic Chlorophenols in Presence of Low Concentrations of Free Chlorine. *Anal. Bioanal. Chem.* **2005**, 383, 1119-1126.
- (195) Fiss, E.M.; Rule, K.L.; Vikesland, P.J. Formation of Chloroform and Other Chlorinated Byproducts by Chlorination of Triclosan-Containing Antibacterial Products. *Environ. Sci. Technol.* **2007**, 41, 2387-2394.
- (196) Welsch, T.T.; Gillock, E.T. Triclosan-resistant Bacteria Isolated from Feedlot and Residential Soils. *J. Environ. Sci. Health A Tox. Hazard Subst. Environ. Eng.* **2011**, 46, 436-440.

- (197) Drury, B.; Scott, J.; Rosi-Marshall, E.J.; Kelly J.J. Triclosan Exposure Increases Triclosan Resistance and Influences Taxonomic Composition of Benthic Bacterial Communities. *Environ. Sci. Technol.* **2013**, 52, 8923-8930.
- (198) Cullinan, M.P.; Bird, P.S.; Heng, N.C.K.; West, M.J.; Seymour, G.J. No Evidence of Triclosan-resistant Bacteria Following Long-term Use of Triclosan-containing Toothpaste. *J. Periodont. Res.* **2014**, 49, 220-225.
- (199) Chen, X.; Casas, M.E.; Nielsen, J.L.; Wimmer, R.; Bester, K. Identification of Triclosan-O-Sulfate and Other Transformation Products of Triclosan Formed by Activated Sludge. *Science of the Total Environment.* **2015**, 505, 39-46.
- (200) Ying G.; Yu, X.; Kookana, R.S. Biological Degradation of Triclocarban and Triclosan in a Soil Under Aerobic and Anaerobic Conditions and Comparison with Environmental Fate Modelling. *Environmental Pollution.* **2007**, 150, 300-305.
- (201) Zhang, X.; Zhang, X.; Niu, Z.; Qi, Y.; Huang, D.; Zhang, Y. 2,4,6-Trichlorophenol Cytotoxicity Involves Oxidative Stress, Endoplasmic Reticulum Stress, and Apoptosis. *International Journal of Toxicology.* **2014**, 33, 532-541.
- (202) Chen, X.; Richard, J.; Liu, Y.; Dopp, E.; Tuerk, J.; Bester, K. Ozonation Products of Triclosan in Advanced Wastewater Treatment. *Water Research.* **2012**, 46, 2247-2256.
- (203) Brillas, E.; Sirés, I.; Oturan, M.A. Electro-Fenton Process and Related Electrochemical Technologies Based on Fenton's Reaction Chemistry. *Chem. Rev.* **2009**, 109, 6570-6631.
- (204) Barbusiński, K. Fenton Reaction – Controversy Concerning the Chemistry. *Ecological Chemistry and Engineering S.* **2009**, 16, 347-358.
- (205) Kremer, M.L. The Fenton Reaction. Dependence of the Rate on pH. *J. Phys. Chem. A.* **2003**, 107, 1734-1741.
- (206) Klammerth, N.; Malato, S.; Maldonado, M.I.; Agüera, A.; Fernández-Alba, A.R. Application of Photo-Fenton as a Tertiary Treatment of Emerging Contaminants in Municipal Wastewater. *Environ. Sci. Technol.* **2010**, 44, 1792-1798.
- (207) Bokare, A.D.; Choi, W. Review of Iron-free Fenton-like systems for Activating H₂O₂ in Advanced Oxidation Processes. *Journal of Hazardous Materials.* **2014**, 275, 121-135.

- (208) Wang, N.; Zheng, T.; Zhang, G.; Wang, P. A Review of Fenton-like Processes for Organic Wastewater Treatment. *Journal of environmental Chemical Engineering*. **2016**, 4, 762-787.
- (209) Methatham, T.; Lu, M.; Ratanatamskul, C. Effect of Operating Parameters on Triclosan Degradation by Fenton's Reagents Combined with an Electrochemical System. *Desalination and Water Treatment*. **2013**, 52, 920-928.
- (210) Saha, N.C.; Bhunia, F.; Kaviraj, A. Toxicity of Phenol to Fish and Aquatic Ecosystems. *Bull. Environ. Contam. Toxicol*. **1999**, 63, 195-202.
- (211) Latch, D.E.; Packer, J.L.; Arnold, W.A.; McNeill, K. Photochemical Conversion of Triclosan to 2,8-dichlorodibenzo-p-dioxin in Aqueous Solution. *Journal of Photochemistry and Photobiology A: Chemistry*. **2003**, 158, 63-66.
- (212) Yu, J.C.; Kwong, T.Y.; Luo, Q.; Cai, Z. Photocatalytic Oxidation of Triclosan. *Chemosphere*. **2006**, 65, 390-399.
- (213) McConnell, E.E.; Moore, J.A.; Haseman, J.K.; Harris, M.W. The Comparative Toxicity of Chlorinate Dibenzo-p-dioxins in Mice and Guinea Pigs. *Toxicology and Applied Pharmacology*. **1978**, 44, 335-356.
- (214) Wisk, J.D. Cooper, K.R. Comparison of the Toxicity of Several Polychlorinated Dibenzo-p-dioxins and 2,3,7,8-tetrachlorodibenzofuran in Embryos of the Japanese Medaka (*Oryzias latipes*). *Chemosphere*. **1990**, 20, 361-377.
- (215) Sijm, D.T.H.M.; Opperhuizen, A. Biotransformation, Bioaccumulation and Lethality of 2,8-dichlorodibenzo-p-dioxin: A Proposal to Explain the Biotic Fate and Toxicity of PCDD's and PCDF's. *Chemosphere*. **1988**, 17, 83-99.
- (216) Sources and Fate of Pharmaceutical Compounds in the Environment. <http://archive.sciencewatch.com/dr/fbp/2010/10febfbp/10febfbpKass/> (Accessed November 6, 2013).

VITA

Matthew Reichert was born in Hammond, IN and has lived across the United States spending time in Illinois, Michigan, Colorado, Montana, and Indiana. He graduated Cum Laude from Taylor University in 2008 with an earned Bachelor of Arts degree in Chemistry, a concentration in Biochemistry, and a minor in Mathematics.

In 2010, he entered the Ph.D. program in Chemistry at Loyola University Chicago. He was awarded the Advanced Doctoral Fellowship during the 2014-2015 academic year. He earned his Doctoral degree in Chemistry in December of 2016.